

FOULING IN THE SEA WATER SYSTEM OF THE  
MARINE SCIENCES RESEARCH LABORATORY,  
LOGY BAY, NEWFOUNDLAND

**CENTRE FOR NEWFOUNDLAND STUDIES**

**TOTAL OF 10 PAGES ONLY  
MAY BE XEROXED**

**(Without Author's Permission)**

GARY A. SERGY



341594

7





FOULING IN THE SEA WATER SYSTEM  
OF THE MARINE SCIENCES RESEARCH LABORATORY,  
LOGY BAY, NEWFOUNDLAND.

by



Gary A. Sergy B.Sc.  
Lakehead University

A Thesis  
submitted in partial fulfilment  
of the requirements for the  
degree of Master of Science  
in Biology

Memorial University of Newfoundland  
St. John's, Newfoundland

July 28, 1972

## ACKNOWLEDGEMENTS

I would like to express my gratitude to the staff, faculty and graduate students of the Marine Sciences Research Laboratory of Memorial University of Newfoundland, for their aid and co-operation during my struggles. X-ray equipment, laboratory space and other facilities were kindly provided by the Marine Sciences Research Laboratory during my period of research. Financial assistance in the form of a University Fellowship was indeed appreciated. Lastly, I thank my supervisor, Dr. John Evans, for his support and friendship these last two years.

## ABSTRACT

A survey, by means of direct and x-radiographic examination, was made of fouling in the poly-vinyl chloride seawater system of the Marine Sciences Research Laboratory, Logy Bay, Newfoundland. Fouling was affected by pipe sizes and configurations, water velocities, continuity of flow and temperature. After four years continuous use, the marine growth was not sufficient to significantly retard operation of the system. The piping system itself, was not designed to facilitate cleaning.

A fungal-bacterial slime film was the first life form observed on new sections of pipe in 1971. The initial dominant macro-foulers were *Molgula* sp. and *Nicolea venustula*.

The communities in horizontal pipes (5.1 cm inside diameter), having had a flow of three and four summer seasons, were studied in detail. Of the 30 species of foulers identified in the pipes, the bivalves *Hiatella arctica* and *Mytilus edulis* constituted the greatest mass; however, *Molgula* sp., *Leucosolenia* sp., *Spirorbis spirillum*, *Anomia simplex*, and *Balanus* spp. were common. *H. arctica* were examined for growth.

Counts were made of the *Spirorbis spirillum* settled on PVC panels hung in the reservoir.

## TABLE OF CONTENTS

ACKNOWLEDGEMENTS. . . . .	i
ABSTRACT. . . . .	ii
LIST OF FIGURES . . . . .	iv
LIST OF TABLES. . . . .	vi
LIST OF APPENDIXES. . . . .	vii
INTRODUCTION. . . . .	1
REVIEW OF LITERATURE. . . . .	3
MATERIALS AND METHODS	
The Sea Water System. . . . .	8
Direct Examination. . . . .	9
X-Radiography . . . . .	9
Settlement. . . . .	10
Plankton. . . . .	10
RESULTS	
The Sea Water System. . . . .	12
Direct and X-Radiographic Examination . . . . .	24
Settlement. . . . .	42
Plankton. . . . .	49
C.N. Ships. . . . .	49
DISCUSSION. . . . .	52
THE SEA WATER SYSTEM AT THE MARINE SCIENCES RESEARCH LABORATORY	
Problems. . . . .	64
Suggestions . . . . .	65
SUMMARY , , . . . . .	67
LIST OF REFERENCES. . . . .	70
APPENDIX. . . . .	75



## LIST OF FIGURES

Figure	Page
1. Aerial Diagram of the Sea Water System . . . . .	14
2. Diagram of the Sea Water Feeder System in the Main Laboratory. . . . .	15
3. Diagram of a Typical Sea Water Pipe System in One Laboratory. . . . .	16
4. Diagram of a Cross-Section of the Reservoir Showing the Arrangement of the PVC Panels . . . . .	17
5. The Reservoir; an External View. . . . .	17
6. Temperature of Incoming Sea Water, 1968-1971 . . . . .	20
7. Relative Irradiance versus Depth of the Reservoir Water . . . . .	22
8. X-Ray of an Air Bubble in a 5.1 cm Horizontal Pipe . . . . .	22
9. A Comparison of the Numbers of Animals, Top and Bottom in the 5.1 cm Horizontal Pipes of Lab 213 and Lab 218 . . . . .	33
10. Longitudinal Section Through a Heavily Fouled 5.1 cm Horizontal Pipe from Lab 213. . . . .	34
11. Cross-Section Through a Heavily Fouled 5.1 cm Horizontal Pipe from Lab 213. . . . .	34
12. X-Ray of a 2.5 cm Valve Showing Bivalve Blockage . . . . .	36
13. X-Ray of the 5.1 cm Horizontal Pipe in Lab 213 . . . . .	40
14. X-Ray of a Dead End Area Showing Mud Buildup . . . . .	40
15. X-Ray of a 5.1 cm Tee Joint. . . . .	41
16. Length versus Relative Frequency of <i>Hiatella arctica</i> taken from the Lab 213-3 Season and Lab 213-4 Season Pipes. . . . .	43

Figure	Page
17. Fouling by <i>Nicolea venustula</i> in the 5.2 cm Acrylic Tubing. . . . .	44
18. Debris and Tunicate Fouling in the 5.2 cm Acrylic Tubing. . . . .	44
19. Configuration of the 5.2 cm Acrylic Tubing Used for Settlement. . . . .	44
20. Partial Season of Settlement of <i>Spirorbis spirillum</i> on PVC Panels Hung in the Reservoir, 1971. . . . .	47
21. Fouling on a 6.5 Month PVC Panel, 1971 . . . . .	47
22. The Difference in Numbers of Nauplius Larve and <i>Ceratium spp.</i> Between Samples of the Reservoir Inflow and Lab 213. . . . .	50

## LIST OF TABLES

Table	Page
1. Flow Rates at the Main Outfalls . . . . .	19
2. Average Water Velocities of Main Pipes. . . . .	19
3. Fouling Animals of the Reservoir. . . . .	26
4. The Relationship of Water Flow to Fouling in Some 5.1 cm Horizontal Pipes . . . . .	29
5. Fouling Animals of the 5.1 cm Horizontal Pipes. . . . .	30
6. Dry Weight in Grams (Shell Included) and Frequency of <i>Hiatella arctica</i> and <i>Mytilus edulis</i> , per Meter of 5.1 cm Horizontal Pipe. . . . .	35
7. Frequency (per cm <sup>2</sup> ) of <i>Spirorbis spirillum</i> on PVC Panels Hung in the Reservoir, June to December, 1971 .	48

## LIST OF APPENDIXES

Appendix	Page
I. Frequency of Animals in 5.1 cm Horizontal Pipe. . . .	75
II. Dry Weight in Grams of <i>Hiatella arctica</i> and <i>Mytilus edulis</i> per Meter of 5.1 cm Horizontal Pipe. . . .	76
III. Number of <i>Hiatella arctica</i> in Each Size Class on the Top and Bottom of 5.1 cm Horizontal Pipes . . . . .	77
IV. Number of <i>Spirorbis spirillum</i> Settled on Poly-Vinyl Panels, 1971. . . . .	78
V. Number of <i>Ceratium</i> spp. and Nauplius Larvae per 57 Liter Sample from Sampling Stations Lab 213 and Reservoir Inflow. . . . .	79

## INTRODUCTION

Marine fouling is here defined as the settlement, growth and accumulation of organisms on submerged surfaces, in such a manner as to cause aesthetic disfigurements, economical losses or technical difficulties for man. With progressing utilization of the sea, the fouling problem has grown. Almost any surface introduced into the sea becomes subject to attack. Most fouling organisms are invertebrate and are sessile or semi-sessile in the adult form, such as barnacles, hydroids, bivalves, and bryozoans. However, some free-living forms also become associated with the fouling community. Examples would include errant polychaetes, gastropods, amphipods and fish.

In a sea water system, the development of fouling communities reduces the capacity of the water supply system and complicates its operation. Organisms on the conduit walls and those which fall off can clog up filters, valves, and condenser tubes.

The sea water pipe system of the Marine Sciences Research Laboratory, Logy Bay, Newfoundland has been in continuous operation since the fall of 1967. During this time, fouling communities have become established. This was initially noted by the animals and dead shells which washed out of the pipes, often blocking valves and filters.

The purpose of this study was to provide a basic survey of the animals in the sea water system and to describe some ecology of

the pipe line community. Forecasts of such fouling conditions cannot be based on outside studies of local conditions because the pipe system offers a different and unique environment to the animal life therein.

## REVIEW OF LITERATURE

Marine fouling in general has been studied quite extensively (Woods Hole Oceanographic Institute 1952), (Second International Congress on Marine Corrosion and Fouling 1968), and has been oriented largely towards anti-fouling technique.

Several detailed studies have been carried out on various fouling communities such as McDougall (1943), Scheer (1945), Coe and Allen (1937), Haderlie (1971) and Kawahara (1962). A worldwide investigation of coastal biofouling by Navoceano is summarized in part by Pastula (1970).

However, little work has actually been done on fouling in sub-arctic waters or on seawater systems. Ships fire mains and cooling water systems have been subject to growth which blocks pipes and sprinkler systems (Woods Hole Oceanographic Institute 1952). Seaboard industries using salt water for cooling, have also experienced problems. Starostin (1963) covers the occurrence of fouling in such technical water conduits of the southern seas of U.S.S.R. Some of his observations included a poor species composition, seasonal fluctuations and a variable fouling density throughout the system. In coastal power stations, the mussel *Mytilus edulis* is the biggest problem (Holmes 1970; Dobson 1946; Sutherland 1967) and a continuous low level chlorination seems to be the best control method. Davis and White (1966) recorded thirty-one species of mollusks from a power station duct. Again, *Mytilus edulis* was always dominant.

There are many factors which influence larval settlement. Not all larvae respond to these factors in the same way and it is quite evident they do have a preference and choice of site. This selection is very important in the final make-up of the fouling community.

The substrate offered for settlement may vary in texture, roughness, and slime composition. Smooth, hard, non-porous, non-fibrous surfaces are relatively poor collectors of sedentary organisms (Pomerat & Weiss 1946). Some barnacles (Crisp and Barnes 1954) and *Hiatella arctica* (Hunter 1949) were found to prefer a groove or crevice to settle in. White (1950) observed that the greatest number of mussels in the power station tunnels were in corners and crevices. Holmes (1970) also noted that settlement takes place first on joints. The organic component of the substrate, the slime film, has been studied by many workers such as Thorson (1957) and Zobell and Allen (1935). In general, larvae prefer a slime film to settle on; however, response may vary with the composition of the film (Meadows and Williams 1963) and with the larval species (Scheer 1945; Crisp and Ryland 1960).

Other factors influencing settlement are response to light and gregariousness. In general, it can be said that larvae prefer shaded or darker surfaces (Thorson 1964; Pomerat and Reiner 1942); however, in the pipes of a seawater system there is no light; therefore, larvae cannot use it to orient themselves. Crisp (1953) found in the absence of light, that there was a direct reaction to



current, causing barnacle cyprids to settle pointing downflow, or after metamorphosis, the young animals rotated (torsion) in such a manner as to cause the cirri to beat into the current. Some animals are gregarious such as *Spirorbis* sp. (Knight-Jones 1951), barnacles (Knight-Jones and Moyse 1961) and oysters (Bayne 1969). Other animals prefer a surface more devoid of their own kind to take them out of intraspecific competition (Thorson 1957).

One of the biggest environmental factors acting on animals in a seawater system is the water flow. This brings food and oxygen, removes metabolic wastes and acts with pressure and shear forces. A slight current seems to be beneficial as mussel productivity is high on water conduits and buoys (Woods Hole Oceanographic Institute 1952). Hutchins and Deevey (1944) concluded that the rate of mussel fouling was augmented by strong tidal currents. Other work on scallops (Gutsell 1930) and mussels (Fox and Coe 1943) showed these bivalves thriving best in areas of higher water movements. Crisp (1955) noted that barnacle cyprids just rolled along the bottom and were not stimulated to settle if the current was not sufficient. Glaus (1968) found that for *Mytilus edulis*, the strength of attachment via byssus threads increased directly with the current.

The current may also be responsible for the settlement pattern on ships. Observations on ship fouling established a relationship between fouling and cruising time. Those ships on active duty were less fouled (Visscher 1928). Ships with a quick turn around period were better off than those which remained in port or cruised coastal

waters. Differences were noted in the amount, type and distribution of fouling organisms on ships (Igic 1968; Hentschel 1923).

A better understanding of the flow of water in pipes can be obtained in the studies of fluid mechanics such as those of Li and Lam (1964) and Coulson and Richardson (1964). Across the pipe there is a velocity gradient, being theoretically zero at the wall and increasing towards the center until maximum. Fouling animals settle and grow on the wall of the pipes, in the boundary layer of transitional velocities and it is these velocities and shear forces which the animal actually experiences. Velocity gradients, and the behavior of barnacle cyprids to them was discussed in detail by Crisp (1955). However, measurement of these velocities was beyond the scope of this study because of the inaccessibility of the pipes and the fluctuating flow. Instead, the average velocities were calculated (Henke 1966).

Once any animal becomes established on a pipe, it provides a roughness to the flow, causing an eddy behind it and turbulence. This makes it much easier for the next animal to settle. Once a community is established, larvae could settle between other animals without the problem of the current being too fast. This was shown by Smith (1946) who noted that the longer the period of stationary attachment, the higher the average velocity needed to prevent further attachment of barnacle larvae, likewise, the higher the velocity needed to retard normal growth of those barnacles already attached. Crisp (1955) noted that once a barnacle cyprid had attached

it could not be pulled off the surface, even by gradients in excess of those preventing attachment. Industrial pipes studied by Starostin (1963) did not have limiting average velocity for growth; rather, the biomass of fouling was directly proportional to the velocity (maximum velocity observed was 2.4 meters/sec.).

The only information found on fouling in Newfoundland waters was provided by DePalma (1969) through his studies in Placentia Sound, Newfoundland. Organisms were collected using wood and asbestos test panels, vertically suspended in the water at a depth of 50 feet and 95 feet (5 feet off bottom), at a .1 to .5 mile distance offshore. DePalma lists 34 species of primary fouling animals, i.e., those which firmly attach to the test panels. Further, he gives growth rates and settlement periods for some of the important foulers. *Hiatella arctica* is described as obtaining a maximum size of 9 mm in 12 months and 15 mm in 24 months. It settled from approximately June 1 to September 1. *Spirorbis* spp. was noted to settle all year round.

## MATERIALS AND METHODS

### The Sea Water System

The description and figures of the sea water pipe system were obtained by visual examination and from the original building blueprints. All measurement given of pipe size refers to the inside diameter.

Estimates of water flow were obtained August 30, 1972 by holding a 190 liter (50 U.S. Gal.) barrel under each outfall and measuring the filling time. All outfalls were measured within a few hours, each one being timed twice. From these measurements the average velocity of the major pipes was calculated by dividing the flow rate by the cross-sectional area (Henke 1966). A history of water use in each lab was compiled where possible. Also, flow rates were measured in each lab on the same day as the outfalls were measured, by observing the filling time of a container of suitable volume. Where this was not possible, estimates were made by comparison with other flows.

Daily measurements of incoming sea water temperatures were recorded since the lab opened. These were taken by a hand held centigrade thermometer on deck 1 (basement area) and occasionally on other decks.

Measurements of relative irradiance were made from surface to bottom of the reservoir using the Hydro Products Relative Irradiance System.

#### Direct Examination

Wherever possible, direct examination of the seawater system was carried out. In all samples collected, the fauna was identified using Bousfield (1960), Gosner (1971), Millar (1966), Miner (1950), Organization for Economic Co-operation and Development (1965), Pettibone (1963), Powell (1968), and Smith (1964).

The sections of pipe collected were fixed in neutralized formalin for 24 to 48 hours, cut longitudinally into two halves, and preserved in 70 per cent isopropyl alcohol. In the 5.1 cm horizontal pipes, counts were made for each species, and comparisons made between the top, bottom and different sections of pipe. All *Hiatella arctica* were measured for length. *H. arctica* and *Mytilus edulis* were dried at 100 C<sup>o</sup> until their weight was constant.

#### X-Radiography

X-rays were taken with a Hotshot portable industrial unit made by Picker X-Ray Corporation. A fine grained, slow film was used (Kodak X-Ray paper for Mammography MA-2, size 20.3 X 25.4 cm (8.5 X 11 inch). The exposures were 90 kilovolts with variations in milliampereseconds and distance. X-rays were taken of various pipes during the spring and summer of 1971. Some had been drained first, but most were full of sea water. Time lapse shots were taken at three locations, at intervals of 1, 7, 30 and 60 days.

### Settlement

A configuration of transparent 5.2 cm acrylic tubing was erected in mid-June 1971 and connected to the main system (at B in Figure 3). The pipes, having a light proof cover and a constant water flow, were examined at weekly intervals for growth. Some 2.5 cm. acrylic tubing was erected on deck 1 on May 28, 1971 and examined for growth until November 17.

A 1.82 meter section of 5.1 cm horizontal poly-vinyl chloride (PVC) pipe was installed January 1971 in Lab 213 (location A in Figure 3) and then removed for examination in December, 1971 after almost one year of use. Other sections of 2.5 cm and 5.1 cm PVC pipe were inserted July 22, 1971 on deck 1 and then removed November 17, 1971.

Two sets of PVC panels were hung on the reservoir on June 1, 1971 (see Figure 4). One set of panels, 17 X 30 cm in size, was left until December 19, 1971. The other set was removed at three week intervals for examination and clean panels replaced. After two such removals, the size of these panels was changed to 5 X 15 cm to facilitate counting. One side was left smooth, while the other side was roughened by a coarse rasp, leaving grooves in the plastic approximately .5 mm wide and slightly less deep.

### Plankton

In an attempt to note any differences in plankton content of water entering the system, from that leaving the system, water samples (each 57 liters) were collected on six occasions from Lab 213 and

from the 10.1 cm pipe entering the reservoir. This was filtered through a 125 $\mu$  sieve, preserved and examined. Counts were made of some of the organisms.

## RESULTS

The Sea Water System

## Description

Before a study of the fouling can be fully understood, some knowledge is needed of the structure and workings of the habitat, the sea water system.

The pipes were poly-vinyl chloride (PVC), a non-corrosive, light, easy to work with material, having a very smooth internal finish. Those pipes exterior to the main lab were fiberglass covered for extra protection.

The water intake originated below ground in the pump house. Water was drawn to the pump by a 15 cm pipe from a sump (approx. 3 meters deep), which had openings to the ocean. The two 100 horse power pumps were each capable of pushing 3785 liters/minute (1000 U.S.G.) against a 30.5 meter head; however, the pumps were not used to full capacity. From the pump house, three 10.1 cm pipes ran uphill to the reservoir (see Figure 1). Only two of the three pipe lines were ever used at once. At one point, there was a branch off which fed the two open air fish tanks.

The reservoir (see Figures 4 and 5) was partitioned into two halves, each side holding approximately 20818 liters (5,500 U.S.G.) and having a depth of 3.35 meters. Each 10.1 cm pipe from the pump house split at the top of the reservoir, feeding both sides at once. Water left each half by a 15 cm raised and perforated pipe on the



bottom. The two 15 cm pipes then went downhill and entered the main laboratory basement (at C in Figure 1). The reservoir fed the main lab by gravity flow and the top of its water column was 32 meters above sea level. Some overflow was always present and this was drained back to the ocean via a salt water stream (D in Figure 1).

In the basement (deck 1) of the main lab, the two 15 cm pipes joined and a number of other lines branched off here. A 15 cm iron and a 10.1 cm PVC line left the main lab, going to the evaporator and diving building respectively (see F in Figure 1). The diving building pipe had only been in constant use since July, 1971. The evaporator was used approximately 3-4 hours, once a day, 5 days a week. It had the capacity to draw 1007 liters/min. for cooling. Also from the basement connection, two 10.1 cm lines branched off to feed the main lab. These 10.1 cm vertical pipes passed up through the floor to deck 2 where they then formed a horizontally located 10.1 cm pipe 'ring' (see E in Figure 1 and Figure 2). Water flowed up each 10.1 cm vertical, around each side of the 'ring' and met at the back.

From the 10.1 cm 'ring' eleven 5.1 cm vertical pipes originate. Each 5.1 cm vertical could be used to feed water to one lab on each deck. The actual labs which received water are indicated in Figure 2 by a small arrow leaving the 5.1 cm vertical. At each point where there is an arrow, the 5.1 cm vertical branches and a 5.1 cm horizontal pipe originates. The 5.1 cm horizontal then entered an individual lab to supply it with running sea water (see Figure 3).

Figure 1

Aerial Diagram of the Seawater System

- A, B - 10.1 cm pipes, three separate lines.
- C - 15 cm pipes, two separate lines.
- D - reservoir overflow.
- E - 10.1 cm pipe 'ring'.
- F - to diving building and evaporator.

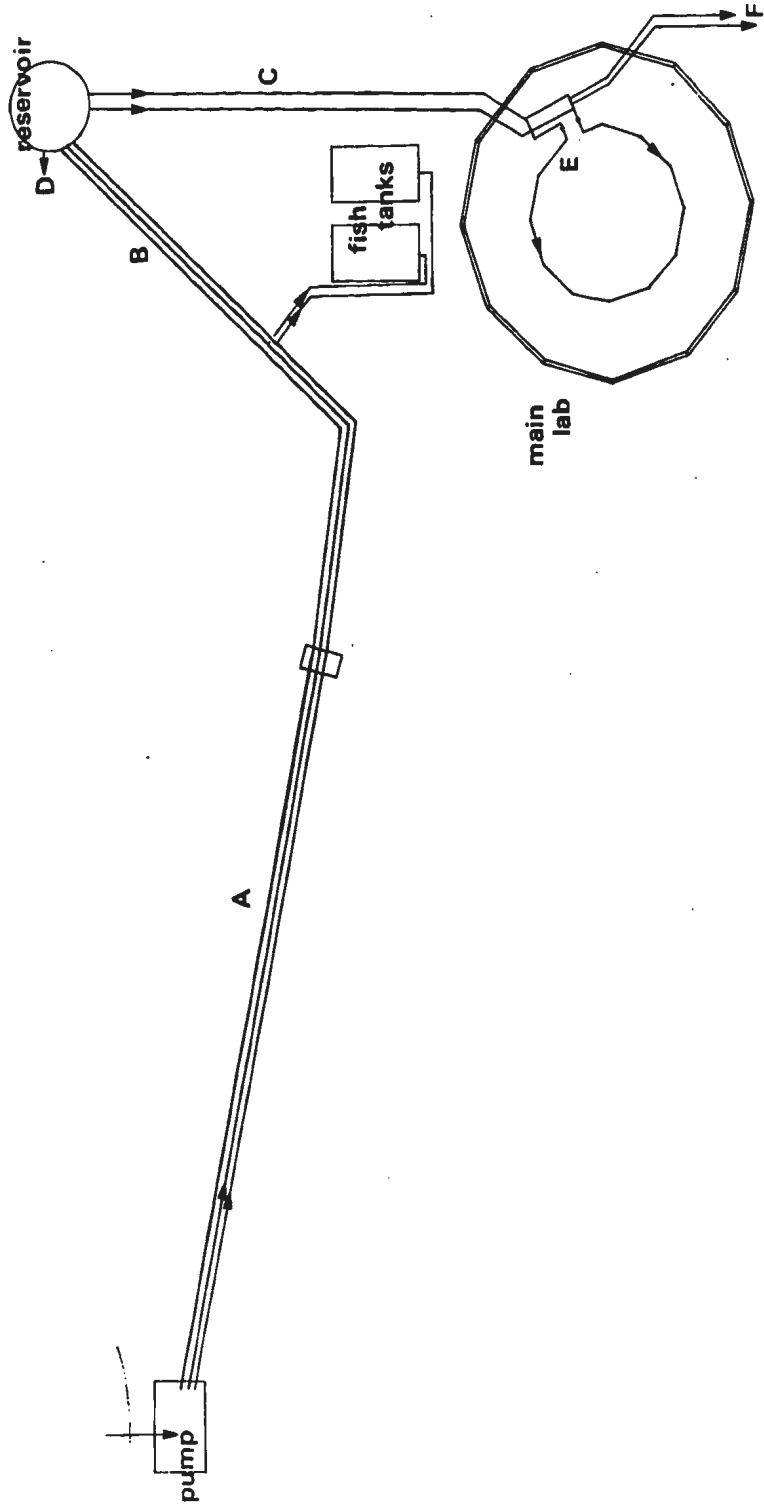

Figure 2

Diagram of the Sea Water Feeder System in the Main Laboratory

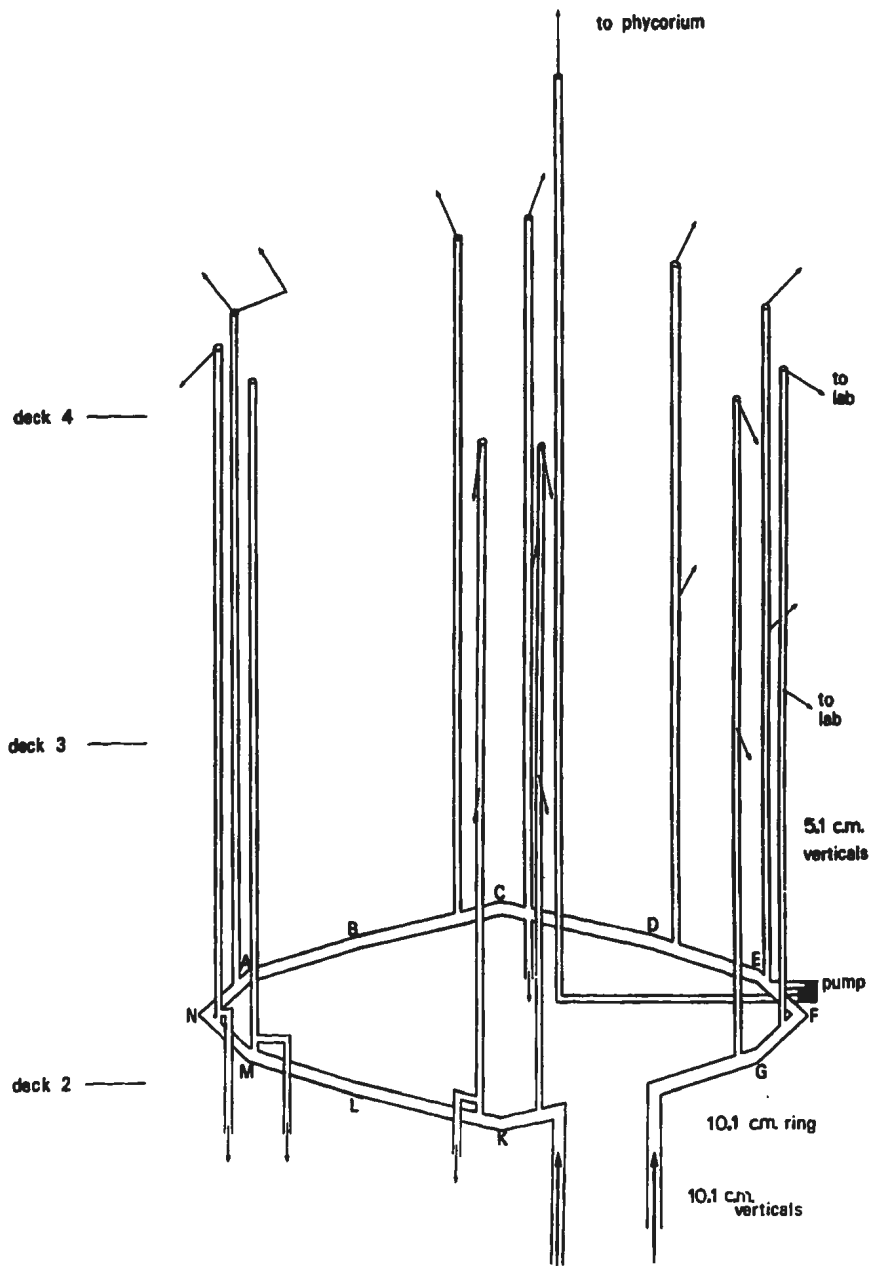
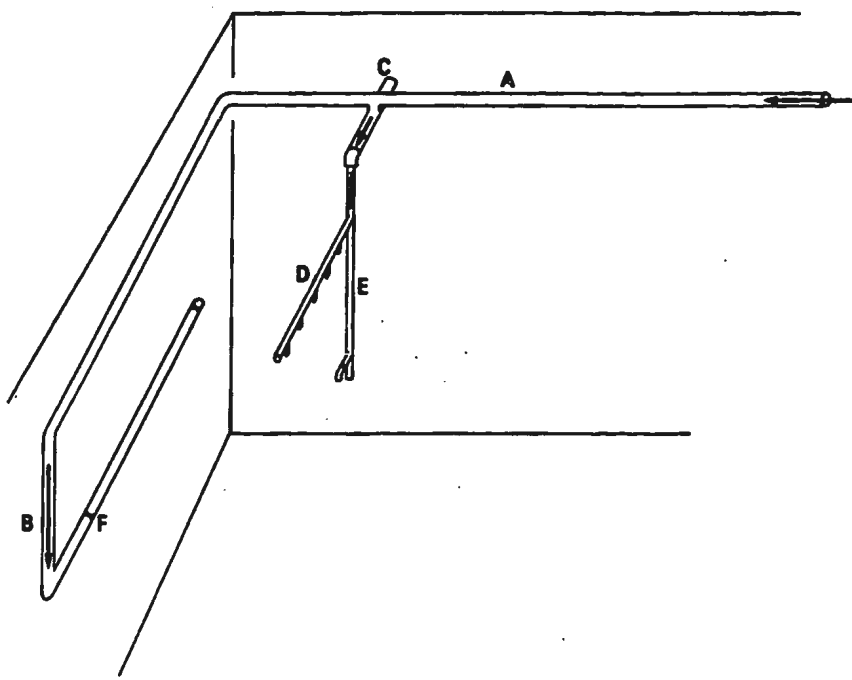
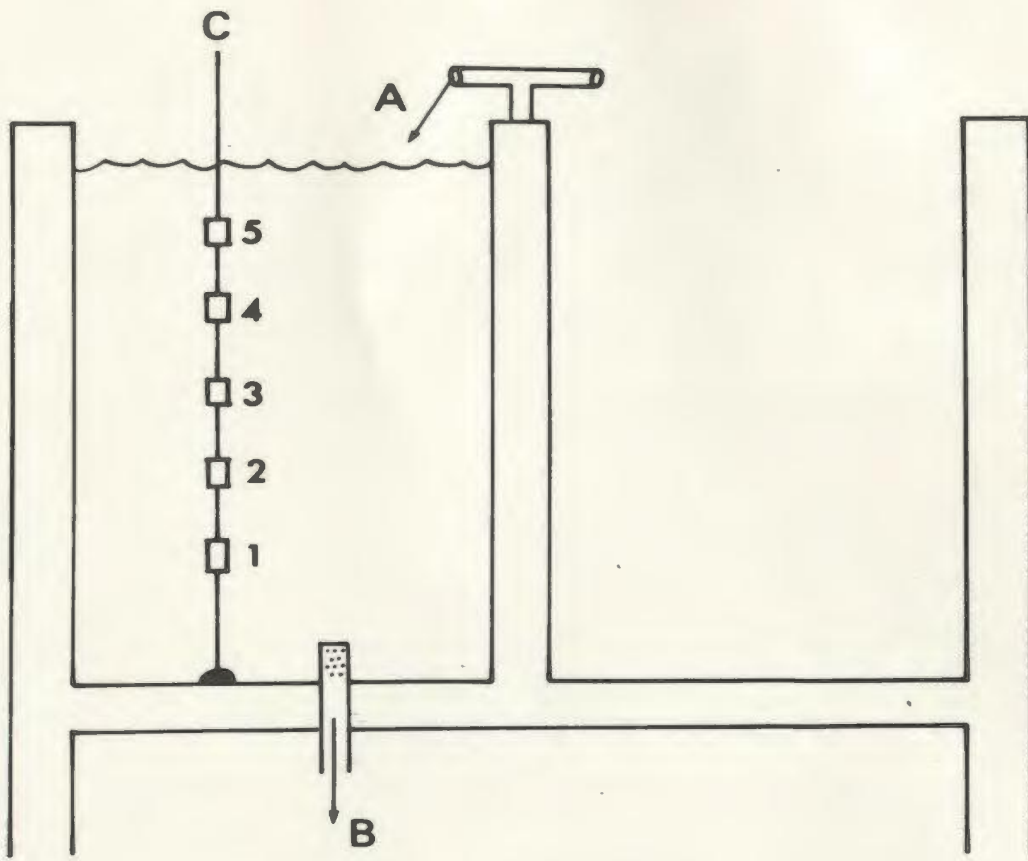

Figure 3

Diagram of a Typical Sea Water Pipe System in One Laboratory

- A -5.1 cm horizontal pipe.
- B -5.1 cm vertical pipe.
- C -a 'dead end' area.
- D -2.5 cm horizontal pipe which supplies the 'A'frames; note the stopcock valves on the underside.
- E -2.5 cm vertical pipe.
- F -location of valve which supplies the wet bench.







The phycorium, which was at approximately the same level as the reservoir, required an auxiliary pump to assure continuous supply. This pump drew water from the 10.1 cm 'ring' (see Figure 2).

In the pump house and reservoir, a series of coarse filters were recently installed (1972). These range in size from 5 to .3 cm mesh diameter.

#### Flow Rates

Measurements of the outfalls gave estimates of the water flows and average water velocity of the main pipes (see Table 1 and Table 2). It must be remembered that these are only a set of values for one day and these values have varied slightly with the fluctuating water demand of the labs. At the time of the main outfall measurements, the flow in each lab was measured or estimated. This totaled to a value of 739 liters/min. which was very close to the main lab outfall value of 735 liters/min. Shortly after these measurements (of August 1971), the water demand to the lab increased considerably due to expansion of M.S.R.L. facilities.

In Lab 213, the flow rate and velocity of the 5.1 cm horizontal pipe was estimated at 43 liters/min. and 21 meters/min. respectively.

#### Temperature

The temperature of incoming sea water for 1968 to 1971 is shown graphically in Figure 6. The temperature ranges yearly between  $-1^{\circ}\text{C}$  and  $13^{\circ}\text{C}$  with the warmest period in mid August. The difference

Table 1  
Flow Rates at the Main Outfalls (August 30, 1971)

Location of Outfall	Flow rate in liters/min.
Open air fish tanks	625
Reservoir overflow (with evaporator on)	42
Reservoir overflow (with evaporator off)	595
Main Lab	735
Diving building	34

Table 2  
Average Water Velocities of Main Pipes  $(\text{Vel.} = \frac{\text{Flow Rate}}{\pi r^2})$

Pipe Size and Location	Figure	Average Velocity in meters/min.
10.1 cm pipe leaving pumphouse	1-A	124
10.1 cm pipe after fishtank cutoff	1-B	85
15 cm pipe from reservoir to main lab	1-C	
1) with evaporator on		37
2) with evaporator off		21
10.1 cm vertical pipe in main lab	2	46

Figure 6  
Temperature of Incoming Sea Water, 1968-1971

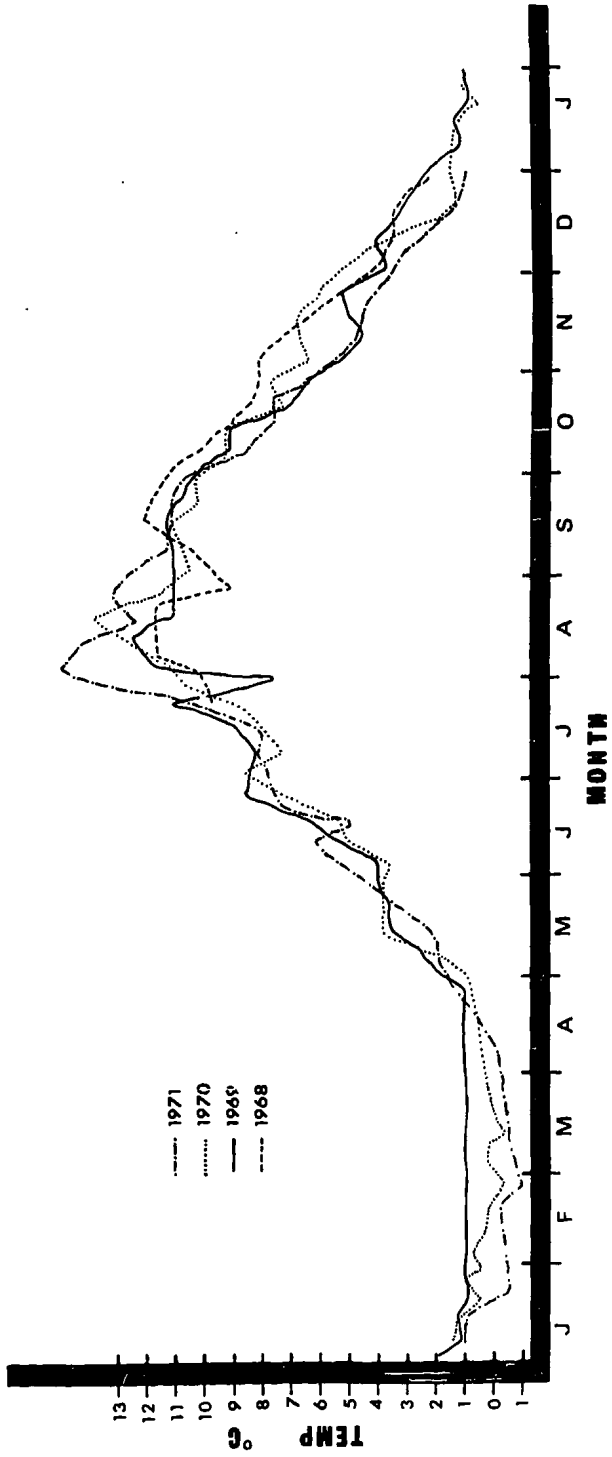

in temperature between any deck of the lab and incoming sea water was always less than 1°C. Pump house water temperatures, with some minor deviations, were in close agreement with the surface waters of Logy Bay (Lin 1972).

#### Relative Irradiance

The relative irradiance in the water of the reservoir is shown in Figure 7. Note there was a 90 per cent loss of light from surface to bottom.

#### Air Bubbles

During examination of the sea water system, several observations were made on the presence of air bubbles.

Turbulent water entering by the 10.1 cm inflow pipe kept the reservoir full of tiny bubbles. Some of these were sucked down into the outflow and thus into the pipe system.

While taking x-rays of the 5.1 cm horizontal pipes, air pockets (see Figure 8) were seen to collect in high spots.

The settlement experiment with the 5.2 cm acrylic tubing revealed bubbles of air constantly coming through the pipes and air pockets which were affected by changes in water flow, such as opening or closing a valve. In the vertical down flow pipes (see a and d in Figure 19), the water was in a constant froth as the bubbles tried to rise against the down flow of water. If water flow was insufficient to force these bubbles down, then an air

Figure 7

Relative Irradiance versus Depth of the Reservoir Water.

Figure 8

X-Ray of an Air Bubble in a 5.1 cm Horizontal Pipe. X1.3

The majority of animals are *Hiatella arctica*. A single scallop is identified by the arrow.

a -air bubble.

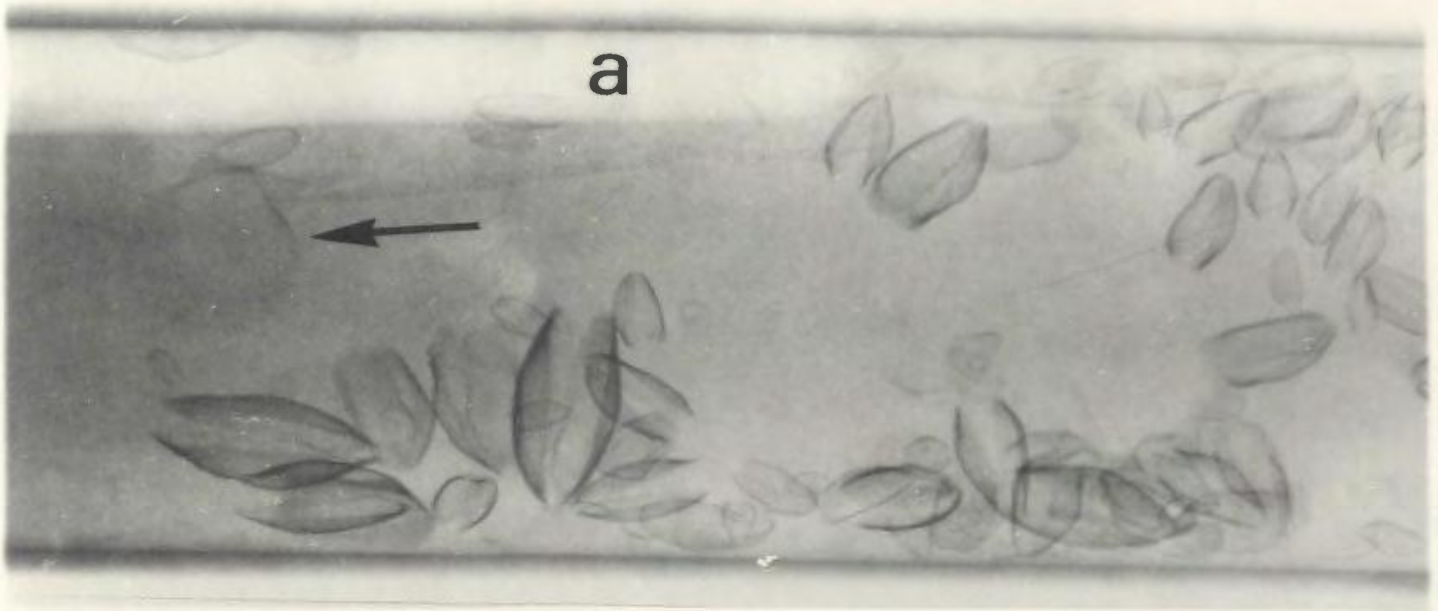
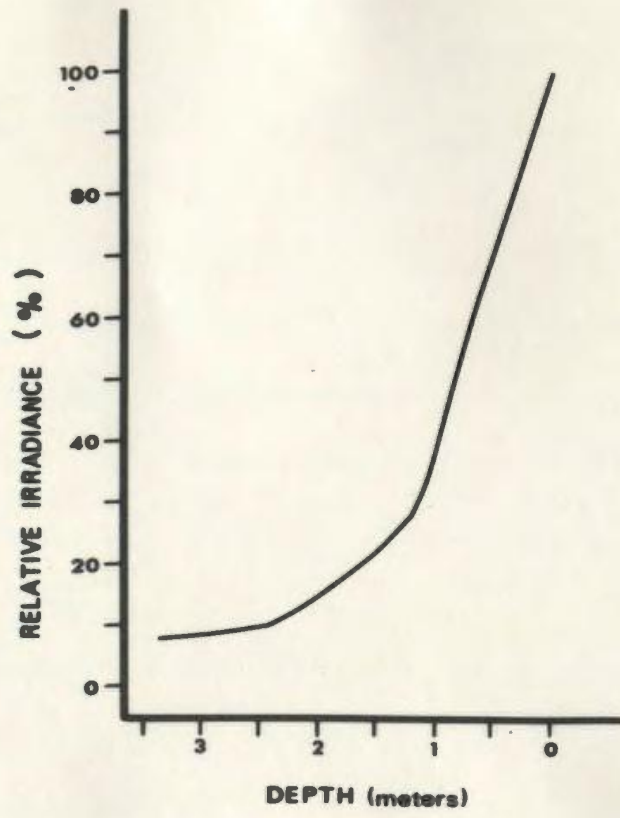

pocket developed. When this happened, the water had to flow along the walls of the pipe since the air pocket occupied the center. In a horizontal pipe such as 'c' in Figure 19, an air pocket collected on the top of the pipe, unless the water flow was sufficiently strong to force the air down the vertical pipe (d in Figure 19). Finally, in a horizontal pipe such as 'e' in Figure 19, the air did not collect, but moved along the top half of the pipe with the flow of water.

One major problem at the M.S.R.L. was the excessive dissolved gas content of the seawater. The result was a formation of gas bubbles in the tissue of fish being kept in the lab. The source and nature of this gas was being studied at the time of this research.

#### Pipe Surface Micro structure

The surfaces of the PVC and acrylic pipes were superficially very smooth. A microscopic examination made to find out how smooth they really were, revealed minute surface structures. Both pipes were quite similar in the size and type of surface structures found. These included mainly small blobs of plastic,  $.5\mu$  to  $5\mu$  in size, and occasionally a larger one up to  $50\mu$ . Usually, these were loosely arranged as ridges running along the length of the pipe. Long narrow grooves were also positioned the same. It was noted that the surface of the pipe was not uniformly covered with the structures described. Rather, they were unevenly distributed,



being dense in some areas to void in others.

No animals were found which had bored into the pipe or damaged the surface. However, this was only examined by use of binocular microscope.

#### Direct and X-Radiographic Examination

The use of x-radiography allowed a look at the animals 'in situ' and a survey of where the animals were located in areas which were otherwise inaccessible. Direct examination allowed more positive identification, counts and measurements of the animals.

Usually, animals less than 3 mm in size or those which were soft bodied, did not show up in the x-rays. However, the most common animals in the pipes were those with shells and these were quite visible. Therefore, it is these animals, mainly *Hiatella arctica*, *Mytilus edulis*, *Balanus* spp. and *Anomia simplex* which are referred to when the amount of fouling growth in a pipe is described by x-radiography.

The effect of draining a pipe for 20 to 60 minutes appeared to be nil on the animals. X-rays showed only some washing of mud and dead shells when the pipe was refilled.

The Fouling: from Pump House to 'A' Frame

Examination of the 15 cm pipes which project into the sump, revealed numerous animals commonly found throughout the system such as: *Hiatella arctica*, *Mytilus edulis*, *Anomia simplex*, *Balanus* spp.

*Spirorbis* spp., tunicates, and ectoprocts. The growth was mainly on the outside of the pipe, the inside being relatively clean. An exception to this was noted in a short section which had holes in the pipe wall to allow water passage. Fouling was heavy inside this one section. Another interesting point is that the *H. arctica* were larger (to 30 mm) in this pipe than anywhere else in the system.

The 10.1 cm pipes from pump house to reservoir (A,B in Figure 1) showed bare in the x-rays. However, sections of pipe located immediately after the pump did contain a coating of brown slime and a few serpulid worms *Spirorbis* spp.

Animals collected from the reservoir walls, sediment and exposure panels are listed in Table 3. In here were found almost all the animals common to the pipes. The reservoir provided hard and mud substrates, variations in light, depth and current. From it could be supplied larvae, adult animals, mud and debris for fouling communities in the pipes. More animals and bottom sediment were found on the east side than on the west side of the reservoir. The bottom was covered by a loose mat of plant material, debris, and an array of dead bivalve shells. Below this was a 6-15 cm layer of fine sediment. The chunks of seaweed entering the reservoir themselves proved to be a problem by settling to the bottom and clogging the basket of the drainage pipe. When this occurred, the water pressure was insufficient to service the top deck of the lab. In November 1970, the reservoir was drained, examined and cleaned.

Table 3  
Fouling Animals of the Reservoir

Phylum	Genus species	Location		
		Wall	Bottom	PVC Exposure Panels
Porifera	<i>Leucosolenia</i> sp.	+		+
	<i>Scypha</i> sp.	+		+
Cnidaria	<i>Metridium</i>	+		+
Annelida	<i>Spirorbis spirillum</i> (Linnaeus)	+		+
	<i>Spirorbis granulatus</i> L.	+		+
	<i>Lepidonotus squamatus</i> L.	+	+	
	<i>Nereis pelagica</i> L.		+	
	<i>Nicolea venustula</i> (Montagu)			+
Arthropoda	<i>Pontogeneia inermis</i> (Kröyer)			
	<i>Balanus balanus</i> L.	+		
	<i>Balanus balanoides</i> L.	+		
	<i>Cancer irroratus</i> (Say)		+	
	<i>Hyas araneus</i> L.		+	
Mollusca	<i>Acmaea testudinalis</i> (Müller)	+		
	<i>Cingula aculeus</i> (Gould)	+		
	<i>Lacuna vincta</i> (Montagu)	+	+	+
	<i>Margarites helicinus</i> (Phipps)	+	+	+
	<i>Hiatella arctica</i> L.	+	+	+
	<i>Mytilus edulis</i> L.	+	+	+
	<i>Placopecten magellanicus</i> (Gmelin)		+	
	<i>Anomia simplex</i> (Orbigny)	+		+
Ectoprocta	<i>Lichenopora hispida</i> (Fleming)			+
	<i>Lichenopora verrucaria</i> (Fabricius)			+
	<i>Tubulipora</i> sp.			+
	<i>Crisia eburnia</i> L.			+
	<i>Callopora craticula</i> (Alder)			+
	<i>Cribrilina annulata</i> (Fabricius)			+
Echinodermata	<i>Asterias vulgaris</i> (Verrill)	+		
	<i>Ophiopholis aculeata</i> L.	+	+	
	<i>Strongylocentrotus dröbbachiensis</i> (Müller)	+	+	
	<i>Chirodata laevis</i> (Fabricius)		+	
Urochordata	<i>Ascidia callosa</i> (Stimpson)	+		+

This was repeated in April 1972. During this period (one summer season) growth was not excessive. Ectoprocts and *Spirorbis* spp. were the most common animals, but tunicates, limpets, snails, sea urchins and crabs were also present.

Examination of the 15 cm reservoir drainage pipe (see Figure 4), revealed a solid buildup 2-3 cm thick around the inside circumference. *Mytilus edulis* was the dominant fouler. *Hiatella arctica*, *Balanus* spp., *Spirorbis* spp, *Nereis pelagica*, tunicates and sponges were also abundant. X-rays taken from this section of pipe down to the main lab basement (c in Figure 1), all showed animals present. The heaviest fouling occurred where the pipes left the reservoir.

The two 10.1 cm vertical pipes (see Figure 2) going from the basement to the 10.1 cm 'ring', were examined by x-radiography and found to be clean. However, x-rays of the 10.1 cm 'ring' gave some interesting results. At the beginning of the 'ring', before any 5.1 cm vertical pipes had branched off, the 'ring' was bare. A little way along the 'ring' after a few vertical feeders had branched off, there were a few animals seen, e.g., 5 animals/x-ray at L in Figure 2, (one x-ray covered 25 cm of pipe). Finally near the back of the 'ring', fouling was much heavier, e.g., 190 animals/x-ray at D in Figure 2.

The 5.1 cm vertical pipes which branched off the 10.1 cm 'ring' were lightly fouled. Scattered growth, 1-16 animals per x-ray was seen. Other 5.1 cm verticals with water flowing down (such as B in Figure 3) looked clean in the x-rays, however, when a

1.37 meter section of this descending pipe from Lab 213 was removed and examined (January 1971), a slight fouling was present. After approximately 2.5 years of use, this pipe had not developed a heavy growth. *Spirorbis spirillum* in a range of sizes was the dominant organism. Rambling colonies of *Leucosolenia* sp. and patches of ectoprocts were common. Other animals included two *Balanus balanoides*, one *Anomia simplex* and a few *Spirorbis granulatus*. A slime film was quite distinct. An exception to the low growth in 5.1 cm verticals was found in one pipe branching off the 10.1 cm 'ring' and leading down to the basement (at N in Figure 2). Very heavy growth of *Mytilus edulis* and some *Hiatella arctica* was found all along this particular pipe.

The bulk of the study done on the pipes was carried out on the 5.1 cm horizontal pipes located in each lab. X-radiography was used to obtain much of the information; however, a few of the pipes were removed for a detailed examination. A comparison of the intensity of fouling organisms in various labs in relation to their history of water use is described in Table 4. The x-rays were taken at the same location in each lab (A in Figure 3) during the spring of 1971. The heaviest fouling found in Lab 213 is shown in Figure 13. Note that Lab 213 and Lab 310 were on the same 5.1 cm vertical line i.e., Lab 310 was directly above Lab 213 and fed by the same 5.1 cm vertical pipe. Such was also the case for Lab 218 and Lab 305.

Four pipes were selected to be removed and studied in detail. Lab 213-1 season pipe, (removed December 1971, 1.82 meters in length).

Table 4  
The Relationship of Water Flow to Fouling in Some  
5.1 cm Horizontal Pipes

Lab	Approximate Flow		Number of Animals per X-Ray (25 cm of pipe)
	Time	Rate	
L213	3 years continuous	high	200 (approx.)
L310	3 years continuous	high	108
L218	2 years continuous	low to medium	55
L305	2 years continuous	low to medium	12
L215	2 years continuous	low	5
L217	2 years intermittent	low to medium	1

High = greater than 36 liters/min.

Medium = 15 to 35 liters/min.

Low = less than 15 liters/min.

Lab 213-3 season pipe, (removed January 1971, 1.67 meters in length).

Lab 213-4 season pipe, (removed December 1971, 1.82 meters in length).

Lab 218-3 season pipe, (removed October 1971, 1.82 meters in length).

In future reference to each pipe, the lab number and number of summer seasons exposure (growth and settlement period) is given. Three of the four pipes were from Lab 213, had the same flow rate but differed in flow time. The flow rate here was constantly high and average velocity was estimated to be greater than 17 meters/min. The fourth pipe was from Lab 218 which appeared to have a lower flow rate.

Average velocity was estimated to fluctuate from 5 to 17 meters/min.

All these 5.1 cm horizontal pipes were removed from a similar location (A in Figure 3). Most of the organisms found were identified and are listed in Table 5, giving a rough estimate of their relative abundance.

Table 5  
Fouling Animals of the 5.1 cm Horizontal Pipes

Phylum	Genus species	Relative Abundance in Pipe				Preferred Location in Pipe
		L213-1	L213-3	L213-4	L218-3	
Porifera	<i>Leucosolenia</i> sp.	+	++	++	++	Top
	<i>Scypha</i> sp.		+	+	+	
Cnidaria	<i>Ectopleura dumortieri</i> (Van Beneden)		+	+	+	Top
Annelida	<i>Spirorbis spirillum</i> (Linnaeus)	+	+++	+++	+++	Top
	<i>Spirorbis granulatus</i> L.		(+)	(+)	(+)	
	<i>Lepidonotus squamatus</i> L.		+	+	++	NS
	<i>Nereis pelagica</i> L.		++	++	++	NS
	<i>Nicolea venustula</i> (Montagu)	++	?	+	++	Bottom
	<i>Cirratulus cirratus</i> (Müller)		(+)			
Arthropoda	<i>Pontogeneia inermis</i> (Kröyer)	+	+	+	+	NS
	<i>Balanus balanoides</i> L.		++	++	++	
Mollusca	<i>Lacuna vineta</i> (Montagu)		+	+	+	NS
	<i>Margarites helycinus</i> (Phipps)	++	++	++	++	NS
	<i>Hiatella arctica</i> L.	+	+++	+++	++	Bottom
	<i>Mytilus edulis</i> L.	++	+++	+++	+++	Top
	<i>Anomia simplex</i> (Orbigny)		+	+	++	
	<i>Placopecten magellanicus</i> (Gmelin)		(+)			
	<i>Mya arenaria</i> L.				(+)	

Table 5--Continued

Phylum	Genus species	Relative Abundance in Pipe				Preferred Location in Pipe
		L213-1	L213-3	L213-4	L218-3	
Ectoprocta			++	++	++	Top
Echinodermata	<i>Ophiopholis aculeata</i> L.	+	+	+	+	NS
	<i>Cucumaria frondosa</i> (Gunnerus)			(+)		
Urochordata	<i>Molgula</i> sp.	+++	++	+	+++	Bottom

Key:

(+) Very Rare  
 + Rare  
 ++ Common  
 +++ Abundant  
 NS Not Sessile



Actual counts made of some of the species (see Appendix I) are illustrated in part (Figure 9) comparing the frequency (per meter) of a species, on the top and bottom of each of the four horizontal pipes. The top and bottom of a pipe was defined by drawing a line through the lateral walls of the pipe, thus making two semi-circles (see Figure 11). In most cases, a sessile animal exhibited a top or bottom preference. This preference for some of the more common animals is given in Table 5.

The dry weight (shell included) per meter of pipe, as well as frequency, is given for the two dominant fouling animals *Hiatella arctica* and *Mytilus edulis* (Table 6). Note the large difference in weight between the two bivalves as compared to the relatively smaller difference in frequency. The average size of *H. arctica* was much larger than *M. edulis* and therefore, it occupied more space in the pipe. About 25 per cent of the *M. edulis* counted in the Lab 213-3, Lab 213-4, and Lab 218-3 season pipe were only 1 to 3 mm in size compared with less than 1 per cent of the *H. arctica*.

Except for *Molgula sp.*, the Lab 213-1 season pipe was very lightly fouled compared to the heavy growth of the Lab 213-3, Lab 213-4 season pipes (see Figures 10 and 11). Likewise, the primary slime was thicker in the older pipes. In general, the bivalves formed a layer one animal deep. The animals were often nestled quite close together, allowing mud and debris to collect between them burying many of the smaller ones. Clumping, although more the exception, was present especially on the bottom half of

Figure 9

A Comparison of the Numbers of Animals, Top and Bottom, in  
the 5.1 cm Horizontal Pipes of Lab 213 and Lab 218.

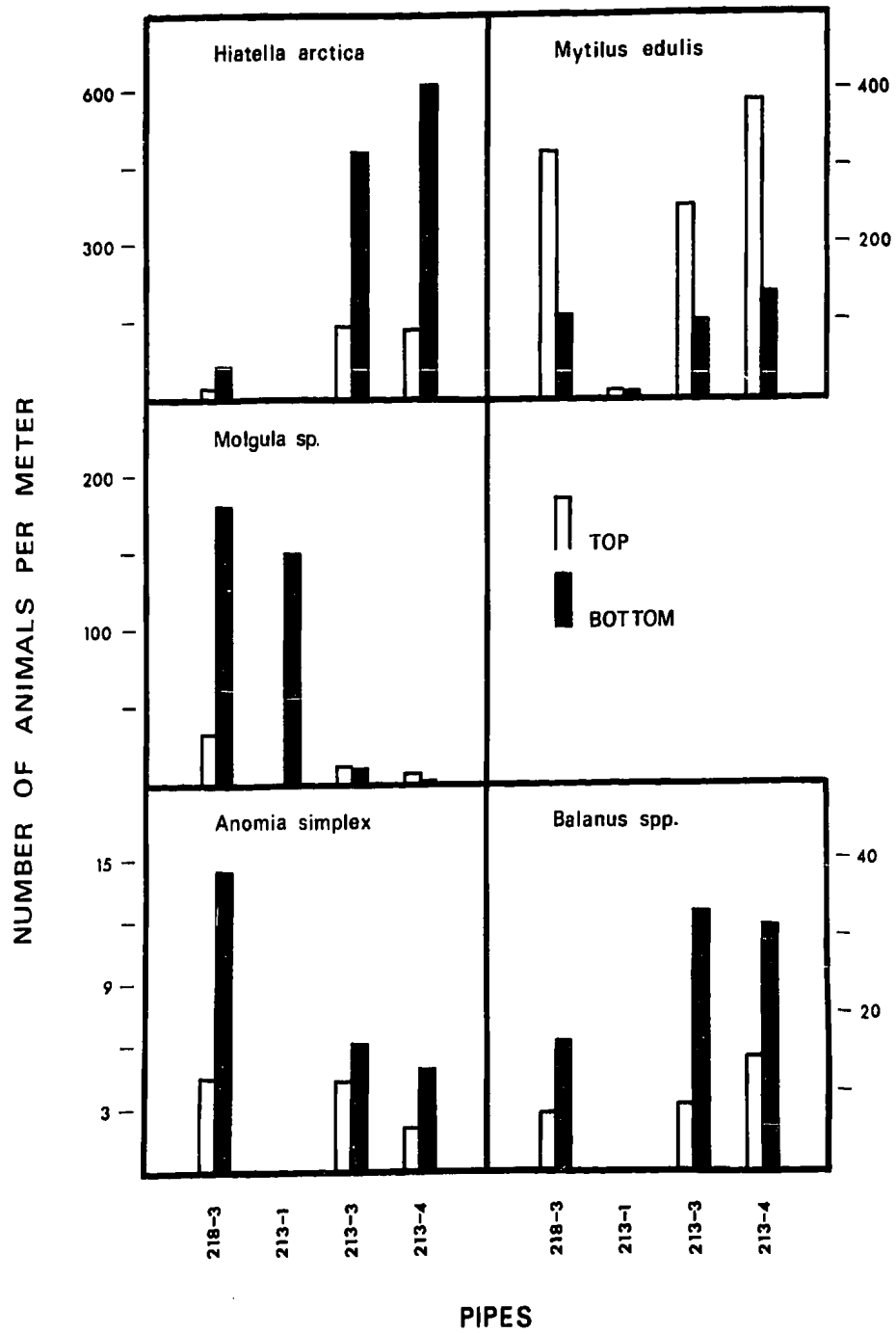

## Figure 10

Longitudinal Section Through a Heavily Fouled 5.1 cm Horizontal Pipe from Lab 213. X1.5 This pipe was cut along the plane of the arrow in Figure 11. Note the abundance of *Hiatella arctica* on the bottom of the pipe.

## Figure 11

Cross-Section Through a Heavily Fouled 5.1 cm Horizontal Pipe from Lab 213. X2.5 The dotted line defines the top and bottom halves of the pipe. The arrow points to the bottom.

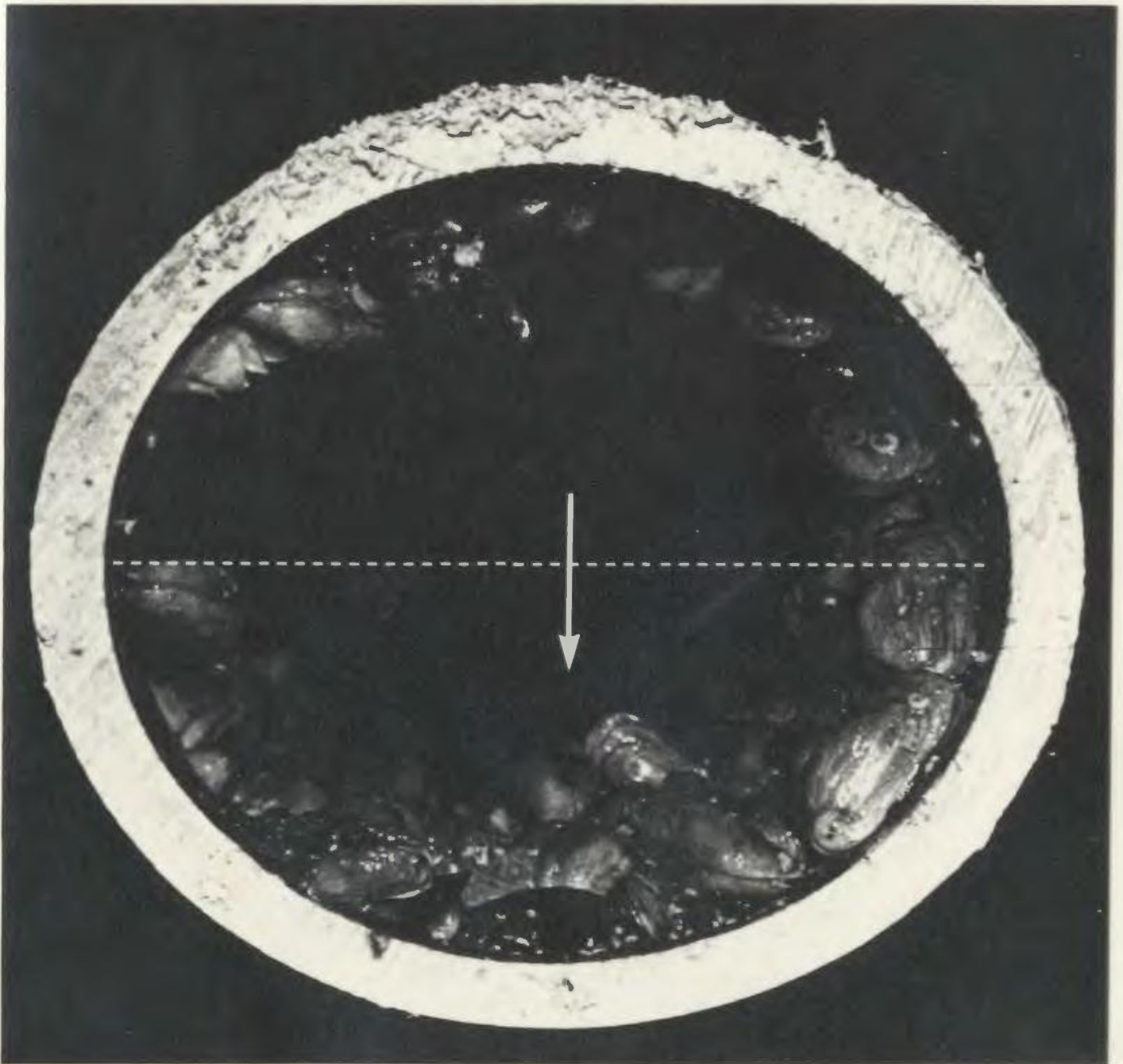

the pipe. Many animals were not attached to the pipe itself but rather to other animals. For example *Spirorbis spirillum* was common on almost all the other animals. Barnacles, tunicates and sponges were noted on *H. arctica*. Often *Molgula* sp. had bivalves embedded in its test and tubes of *Nicolea venustula* connected to it.

Table 6

Dry Weight in Grams (shell included) and Frequency of  
*Hiatella arctica* and *Mytilus edulis*, per Meter  
of 5.1 cm Horizontal Pipe

		L218-3	L213-3	L213-4
Dry Weight	<i>H. arctica</i>	4.12	47.31	71.84
	<i>M. edulis</i>	2.31	3.22	9.41
Frequency	<i>H. arctica</i>	82	623	728
	<i>M. edulis</i>	427	348	524

The last pipes to be mentioned are the 2.5 cm lines which supply the 'A' frame tables. The horizontal 2.5 cm pipe (see D in Figure 3) had stopcocks on its underside which continually became plugged. X-radiography showed a blockage due to bivalve shells (see Figure 12) too large to pass through the stopcock valves. X-rays on the 'A' frames of four different labs all gave similar results, even in one line which was frequently blown clean by high velocity water. The dead shells in the stopcock wells were mainly *H. arctica* and *Anomia simplex*. Sections of horizontal and vertical 2.5 cm pipes (D and E in Figure 3) removed from Lab 213 in July 1971,

Figure 12

X-Ray of a 2.5 cm Valve Showing Bivalve Blockage. X1.3 Note the accumulation of dead shells in the well of the stopcock valve.

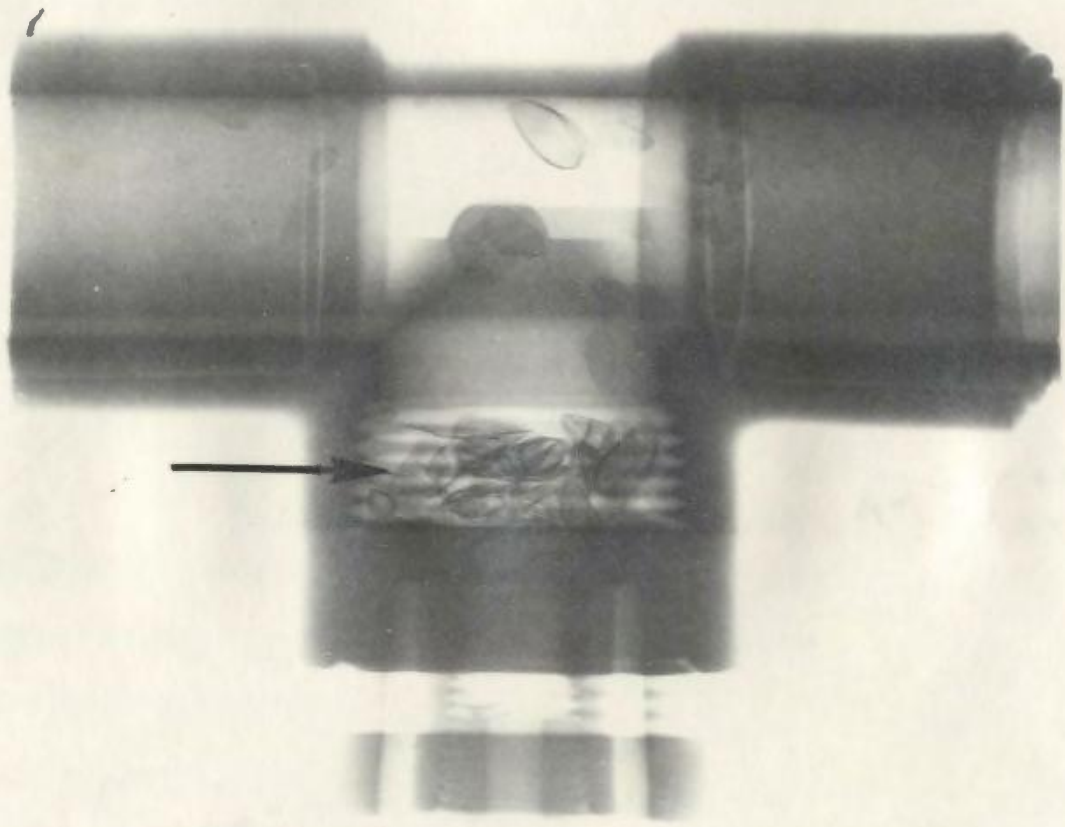



showed a heavier buildup in the horizontal section. Organisms present were mainly *Leucosolenia* sp., *Spirorbis spirillum*, and ectoprocts. A few *Anomia simplex* and *Mytilus edulis* were located in the horizontal pipes. Fouling was much lighter in these 2.5 cm pipes compared to the 5.1 cm horizontal pipes in the same lab.

#### Miscellaneous Observations on Some Animals in the Pipes

During examination of the pipes, a brown slime was always noted to be present. It was composed of a filamentous fungus and numerous species of filamentous bacteria. Amidst the filaments were a few free living micro-organisms and detritus. The slime film was the first life form on a newly immersed substrate, appearing within hours.

*S. spirillum* in the Lab 218-3 season pipe were in patches (approx. 3 cm in diameter) about 20 to 60 cm apart. Their density was approximately 14 worms per cm<sup>2</sup> in the patches. In the Lab 213-3 and Lab 213-4 season pipes, patches were less distinct as the area between patches had also been settled. Density here varied from 5 to 30 worms per cm<sup>2</sup>. Counts in the 5.1 cm vertical pipe from Lab 213, ranged from 8 to 13 worms per cm<sup>2</sup>.

A few empty shells of *Anomia aculeata* (Gmelin) were noted, but no live specimens were found.

Besides those ectoprocts from the reservoir listed in Table 3, a couple of other species were found in the pipes. These were *Bicellariella ciliata* (Linnaeus) and *Cylindroporella tubulosa* (Norman).

It was noted that the sponge *Scypha* sp. was always bent with the flow of water such that the osculum opened away from the source of current. Likewise, over 90 per cent of all barnacles examined in x-rays were positioned so that the rostrum was oriented towards the source of current. Such orientations could be used to determine the direction of flow in a pipe, if for some reason it was unknown.

#### Mud, Backwashes and Joints

Decaying plant matter, mud, animal faeces, and bivalve shells collected in the pipes. This mud-debris built up behind partially opened valves, in areas of eddies and around the shells of living animals. Clean out plugs, depending on how they were located, provided a catch basin for the mud-debris or a shallow backwash area for settlement. An empty water filter bowl, connected to the 2.5 cm horizontal pipes, was removed from Lab 213 in August 1971 after approximately 1.5 years of disuse. The bowl acted like a catch basin and the deposits in it were probably typical of other backwash areas. On the bowl bottom was approximately 5 cm of sediment and dead bivalve shells. Living animals included the bivalves: *Hiatella arctica*, *Mytilus edulis*, gastropods *Margarites helicinus*, *Lacuna vineta*, polychaetes *Nereis pelagica*, *Amphitrite cirrata* (Muller), *Spirorbis spirillum*, brittle star *Ophiopholis aculeata*, amphipod *Pontogeneia inermis* and various ectopods. The bowl surface, although transparent and exposed to light, contained no algae or slime film.

In dead end areas (such as C in Figure 3), the deposition of

mud depended on the amount of backwash, which varied with the water flow. Often the fouling bivalves would clump at the entrance to these areas (Figure 14).

Between a pipe and any type of connector or fitting, there is a joint or crack. Fouling was usually heavier on the crack than the immediate surrounding area, e.g., counts made of the bivalves in x-rays of a Tee from the same location in six different labs, showed 106 animals on the crack compared to 61 animals on the flat surface. Results from the x-rays of other fittings were similar (see Figure 15).

Young *Hiatella arctica*, less than two months old, were collected from open water September 1, 1971 and transplanted into a 5.1 cm horizontal pipe. Examination after two months showed that only a few had remained in the straight pipe. Most had moved down the pipe and squeezed in the crack of an elbow joint.

#### Time Lapse X-Rays

The time lapse x-rays taken on 5.1 cm horizontal, vertical and Tee joint pipes, showed no major changes, however, many bivalves did shift their angle to the flow. Only a few were seen to do this in 24 hours, but after 30 days, most of the bivalves had shifted angle. Some were noted to move their position entirely, e.g., after a time lapse of 7 days, one mussel had moved about 1 cm to a upflow position and a new mussel appeared which was not there a week ago. After another time lapse of 21 days, the new mussel was relocated

Figure 13

X-Ray of the 5.1 cm Horizontal Pipe in Lab 213. X1 The majority of animals visible are *Hiatella arctica*.

- a -*Mytilus edulis*.
- b -barnacle.

Figure 14

X-Ray of a Dead End Area Showing Mud Buildup. X1

- a -points to a clump of bivalves near the open end of the pipe.
- b -deposits of mud and debris along the bottom of the pipe.



14



13

Figure 15

X-Ray of a 5.1 cm Tee Joint, X1    The arrow shows the direction  
of water flow. Note the abundance of bivalves in the crevice.

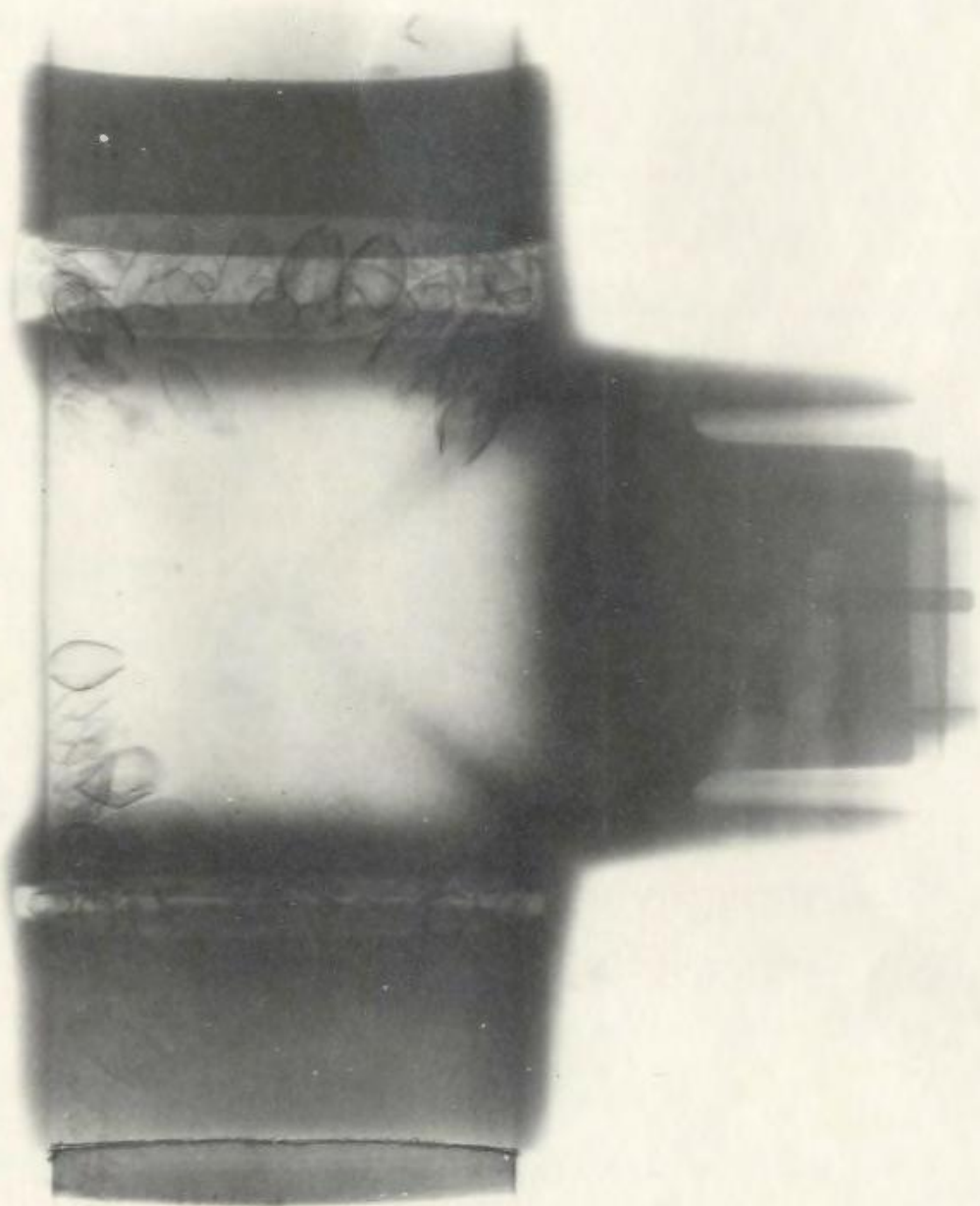

4 cm upflow.

#### Measurement of *Hiatella arctica*

*Hiatella arctica*, the dominant animal of the heavily fouled pipes, was looked at in more detail to try and find information on its growth. All the *H. arctica* in the four sections of 5.1 cm horizontal pipes from Lab 213 and Lab 218 were measured for length (Appendix III). In Figure 16 the relative frequency of the measurements for the Lab 213-3 and Lab 213-4 season pipes is given, i.e., the number in each size range is given as a per cent of the total number for each pipe.

#### Settlement

##### Acrylic Tubing

Weekly observations on the 5.2 acrylic tubing starting mid-June 1971, gave some indication of the initial fouling process. The average velocity of water flow was approximately 18 meters/min.

After two weeks, patches of dark brown debris began to collect on the bottom half of the pipe (e in Figure 19). By three weeks, snails (*Margarites helicinus*) and copepods moved freely about the pipe surface. A few minute *Mytilus edulis* were present, but then disappeared after a couple of weeks. Also at three weeks, a brown filamentous slime was visible. This started as individual specks and if it got thick enough, formed a continuous mat. The patches of debris (on pipe e in Figure 19) slowly built up and seemed to have



## Figure 16

Length versus Relative Frequency of *Hiatella arctica* Taken from the Lab 213-3 Season and Lab 213-4 Season Pipes. The value given for the length is the class marker, e.g., a length of 9 mm contains the animals of a size 8.5 to 9.49 mm. The values are broken down to give the percentage of animals in each size class on the top and bottom of the pipe.

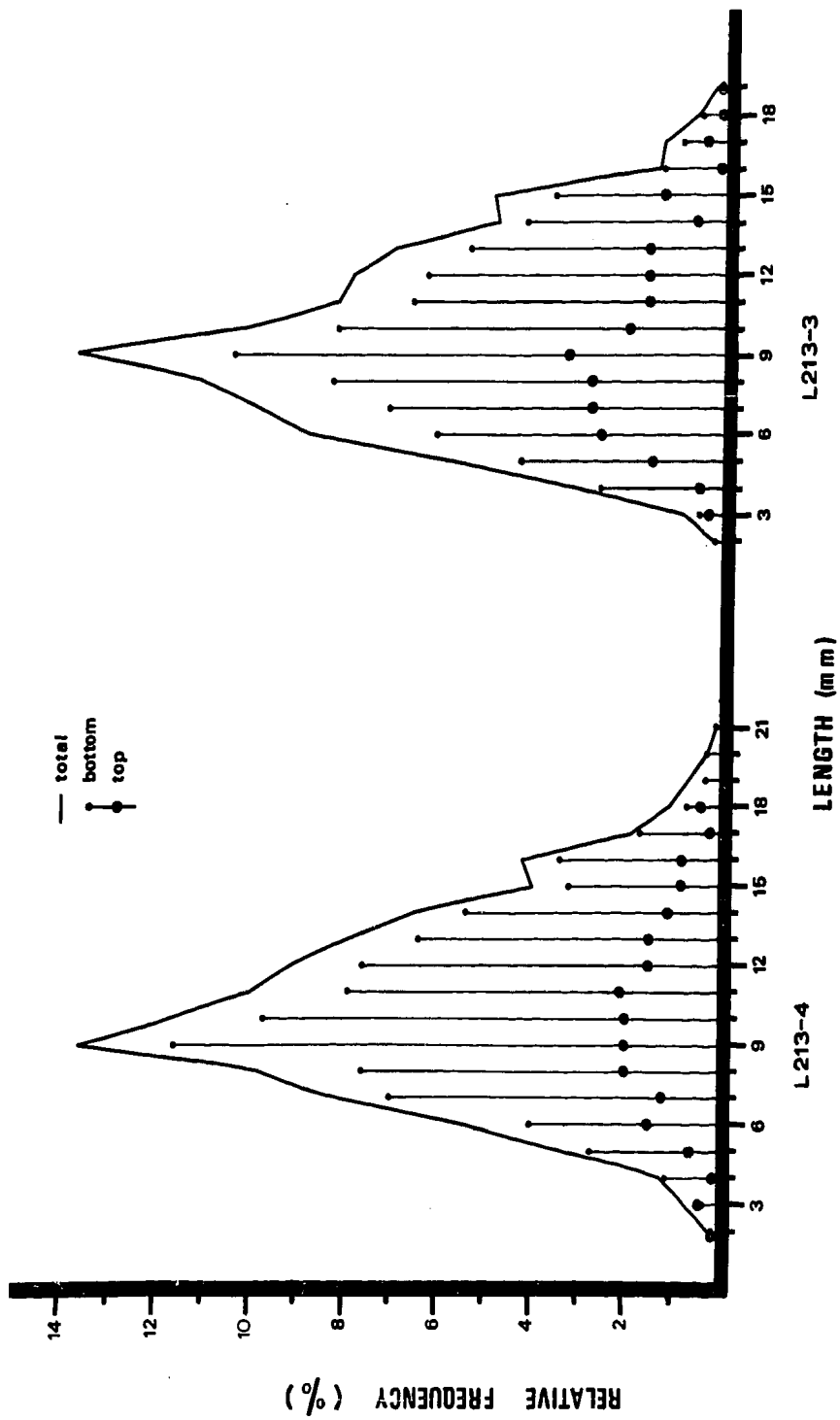

Figure 17

Fouling by *Nicolea venustula* in the 5.2 cm Acrylic Tubing.  
Note the tentacles extending from the anterior end of the  
worm tube. The arrow points out a tunicate.

Figure 18

Debris and Tunicate Fouling in the 5.2 cm Acrylic Tubing.  
The arrow points to one of the tunicates.

Figure 19

Configuration of the 5.2 cm Acrylic Tubing used for Settlement.  
The arrow points the direction of water flow.

a,b,d, - vertical pipes.  
c,e - horizontal pipes.

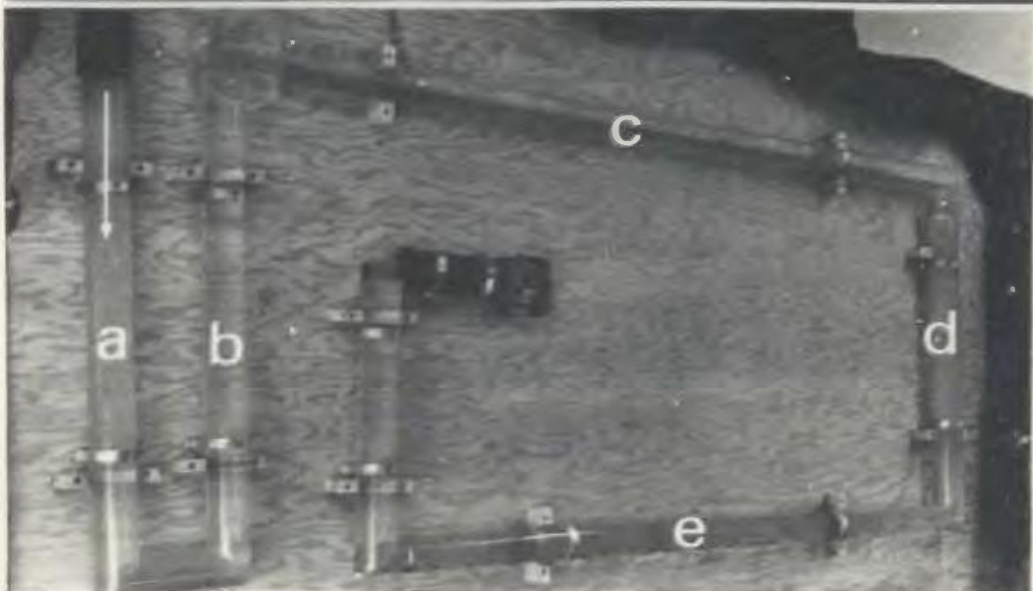

some dense central body to which everything adhered. By five weeks, small tunicates could be seen among the debris (see Figure 18). A few tunicates were noted on the vertical pipes, but these did not thrive. Also at this time, polychaete tubes were seen in the debris which looked like those of *Nicolea venustula* (see Figure 17). A few Spirorbids were noted scattered along the pipe.

By April 1972 there had been little change in the condition of the pipes. As before, the growth was almost entirely in the horizontal pipe 'e' (Figure 19), on the bottom location. *Margarites helycinus*, *Lacuna vineta*, and two species of Spirorbis were present. The tubes of what were presumably *N. venustula* were abundant on the bottom of the pipe (approx. 25 worms/meter). The tunicates were covered with mud-debris. However, the bases of the larger ones could be seen from the underside of the transparent pipe. These numbered approximately 35 tunicates per meter of pipe, but the actual count, including small ones, was probably double this value.

The 2.5 cm horizontal acrylic tubing erected on deck 1 was slow in fouling. Little happened until late August 1971 when a small amount of debris appeared. The scanty growth present on removal consisted of *Molgula* sp., *N. venustula*, *Spirorbis* spp. and some slime film.

#### PVC Pipes

Various sections of horizontal PVC pipe were examined. A 2.5 cm pipe on deck 1 grew only some slime film between July 22, 1971

and November 17, 1971. However, a 5.1 cm pipe in the same lab and with similar flows, also became fouled on the bottom half by the tunicate *Molgula* sp. and polychaete *Nicolea venustula*. Another section of 5.1 cm pipe connected from September 1, 1971 to December 1, 1971 in Lab 213, collected only *N. venustula* on the bottom half. The 1.82 meter section of 5.1 cm horizontal pipe installed January 1971 to December 1971 in Lab 213 has previously been described.

#### PVC Reservoir Panels

Poly-vinyl chloride panels were hung in the reservoir as illustrated in Figure 4 with each set of five panels spaced equidistant from top to bottom. On those panels immersed for three week intervals, settlement was insufficient to warrant counts except for the polychaete *Spirorbis spirillum*. These results are given (Appendix IV) as the number of worms on each side of the panel (rough-smooth), at each depth (panels 1 to 5), on each date (3 week interval). A partial settlement period of *S. spirillum* was ascertained by counting total settlement for each series of three week, 5 X 15 cm PVC panels. The intensity of settlement is shown in Figure 20.

A comparison of settlement *S. spirillum* on the rough and smooth side of the 5 X 15 cm three week panels revealed no significant difference between the two populations at the .05 level. Also, the interaction between rough-smooth settlement and season of settlement

Figure 20

Partial Season of Settlement of *Spirorbis spirillum* on PVC Panels Hung in the Reservoir, 1971. The total worm count refers to the total number of *S. spirillum* settled on all five (5 X 15 cm) panels, each three week time interval. Note that the period Oct. 4 to Oct. 18 was only two weeks and the value given in the graph is an estimate of settlement in a three week period.

Figure 21

Fouling on a 6.5 Month PVC Panel, 1971. X2 Spirorbids and ectoprocts are the main foulers.

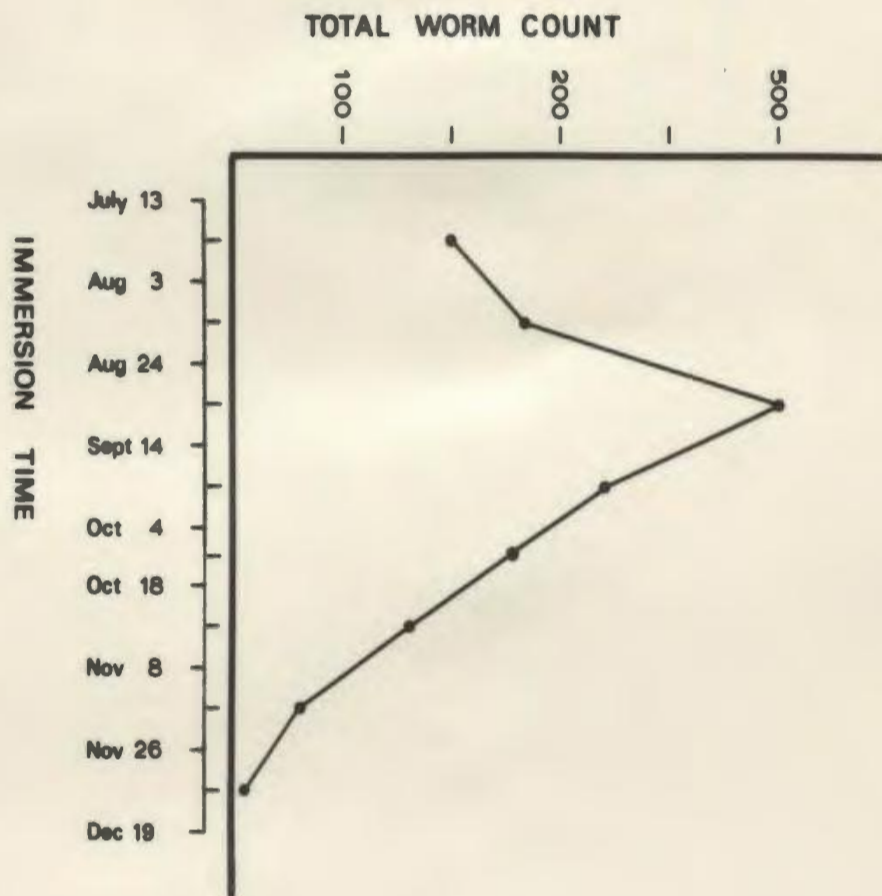



was not significant at the .05 level.

Table 7

Frequency (per cm<sup>2</sup>) of *Spirorbis spirillum* on PVC Panels  
Hung in the Reservoir, June to December, 1971

Panel	Depth (meters)	Frequency	
		6.5 Month Panels	Total from 8 Sets of 5 X 15 cm, 3 week panels
5	.55	12.7	1.7
4	1.11	20.8	1.6
3	1.67	38	2.5
2	2.23	33.5	2.3
1	2.79	29.3	3.3

The set of panels immersed for a 6.5 month period had a much heavier and varied growth of animals. These were listed in Table 3. Figure 21 shows one of these panels. Tunicate and spirorbid fouling is evident. Counts made of *Spirorbis spirillum* are given in Table 7. Note that there is some stratification due to depth in both the 6.5 month and the three week panels.

Although only *S. spirillum* was counted, gross observations were made on the bulk of fouling settlement. It was noted that settlement started late June and carried through to November - a period of slightly longer than four months. The heaviest settlement was in late August to early September.

### Plankton

Only a crude examination was made of the plankton in water samples from the reservoir inflow and Lab 213. Although bivalves, snails, nematodes, ostracods, tinntinids and many other organisms were present, counts were made only on the dinoflagellate *Ceratium spp.* and nauplius stage larvae. The difference in numbers of these two organisms between reservoir and lab samples is illustrated (Figure 22). There was clearly a large loss of plankton between the two sampling points.

There was also some gross observations on the plankton samples which should be noted. The reservoir samples contained more live material than Lab 213, and all the plant debris was fresh. In the Lab 213 samples, there was much more debris and all of it was dead and decaying. Animal faeces, abundant in the Lab 213 samples, were not seen in the reservoir.

### C.N. Ships

The severity of fouling on local ships was observed at the St. John's harbour and C.N. drydock. Generally, the hulls of the ships were quite clean, some of them using cathodic protection.

A closer examination was made of the sea water system of one of the C.N. ferries. The iron pipe system carries sea water for cooling and sanitary disposal. Baskets located at possible clog up points must be emptied once a month. These catch loose mussel shells from the pipes and sea weed which is pulled in the intake.

Figure 22

The Difference in Numbers of Nauplius Larvae and *Ceratium spp.*  
between Samples of the Reservoir Inflow and Lab 213.

- Sample 1 -August 16, 1971.
- 2 -August 26, 1971.
- 3 -September 24, 1971.
- 4 -October 7, 1971.
- 5 -October 27, 1971.
- 6 -November 11, 1971.

- a -Lab 213 sample.
- b -reservoir inflow sample.

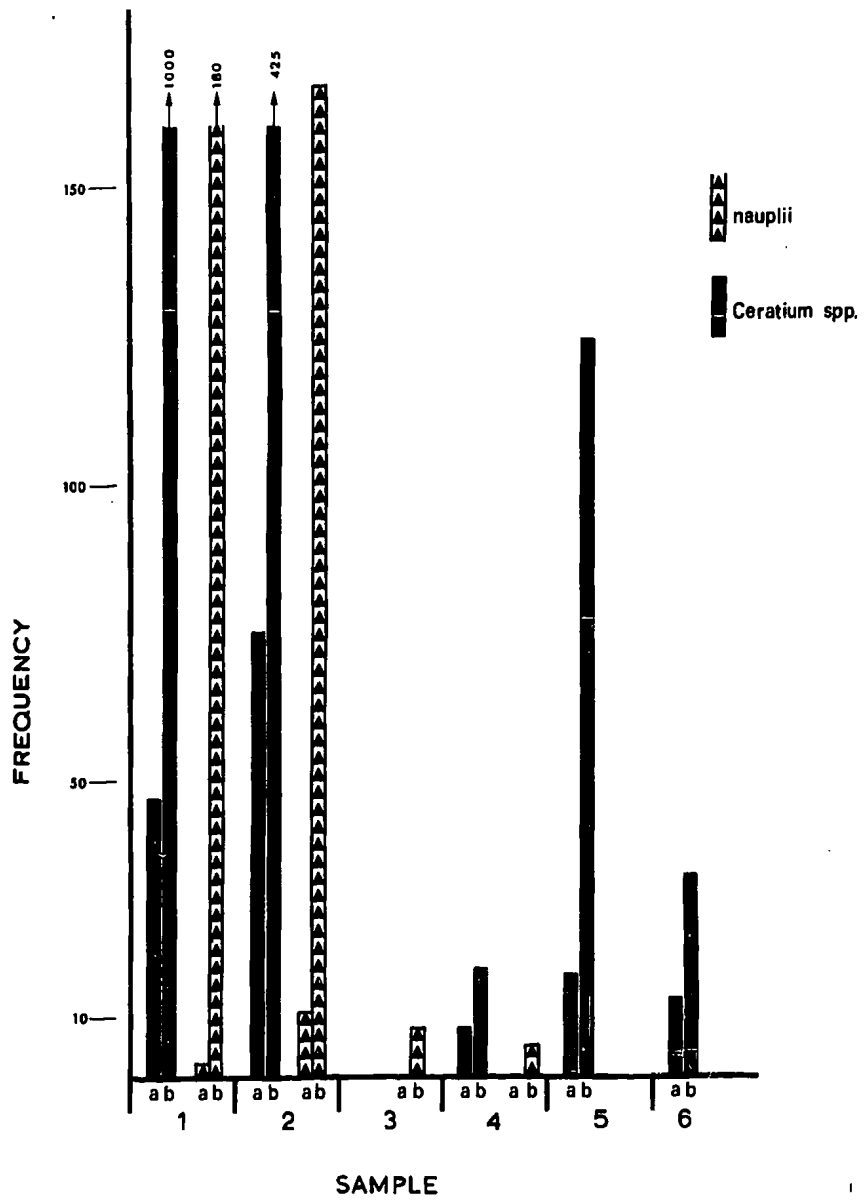

Through necessity, the ferries are serviced once a year, by which time the seawater system is thoroughly plugged with mussel growth. An acid type chemical is pumped through the system. This results in the mussels and large amounts of rust, to be dislodged and then flushed along to the collecting baskets. The mussels (*Mytilus edulis*) were 1.5 to 3 cm in length. Some *Balanus* spp. and an erect ectoproct were also noted.

## DISCUSSION

The location of the Marine Sciences Research Laboratory, Logy Bay, Nfld., makes it one of the most suitable research stations for studies in sub-arctic marine biology. There is ready access to the waters of the North Atlantic and a continuous supply of clean cold polar water from the Labrador Current. The waters of the M.S.R.L. have a relatively short period of elevated temperatures, in comparison to other marine laboratories. DePalma (1969) states the limiting temperature for settlement and growth of most foulers is 6.7°C (44°F). Although not true for some arctic forms (Thorson 1950), it was found to be a fairly accurate figure for the settlement of fouling species found in this survey. Referring to the temperature graph (Figure 6), this would set a settlement season in the sea water system of the M.S.R.L. from approximately late June to early November, or 4.3 months. In fact, observations on PVC panels in the reservoir gave a similar time period for settlement. However, in the pipes, the settlement season appeared slightly shorter (July - September). The mussel *Mytilus edulis*, in the Baltic Sea, is subject to the temperature, with approximately 6°C required for normal development (Kujawa 1968). DePalma (1969) noted *Hiatella arctica* settled in Placentia Sound, Newfoundland from June to the end of August. On PVC panels in the reservoir neither of these bivalves were seen until late August when temperatures were high. Likewise bryozoans settled in early July and barnacle cyprids were observed as early as June. In the

acrylic pipes, the tunicate *Molgula sp.* was noted to settle in July and the polychaete *Nicolea venustula* from July to September. Long (1972) also observed fouling organisms to attach between June and October in the waters off the Kodiak Island, Alaska. Most species were boreal or sub-arctic in distribution. Besides settlement, the summer season also produces the maximum growth period of many animals. In the cold winter waters growth is slowed down. For example, the growth curve of *Mytilus edulis* follows closely the temperature curve up to 15°C and growth of *Balanus spp.* is also temperature regulated (Woods Hole Oceanographic Institute 1952).

Such a short summer season may account for the relatively light growth in the M.S.R.L. seawater system after approximately 4 years of operation. Many other marine laboratories have experienced problems in fouling and siltation. A summary of the situation at some of these laboratories is given by Sprague (1966). It is noted that a twice yearly shutdown due to marine fouling is not uncommon. The M.S.R.L. is lucky to have escaped such heavy fouling because the present design of the seawater system does not allow adequate cleaning. A summary of its problems and some suggestions are found at the end of the discussion.

There may be other reasons besides temperature for the light fouling experienced in the M.S.R.L. One would be the smoothness of the PVC pipe (Pomerat & Weiss 1946). Another might be the water flows, as discussed later. Whatever the reason, they were certainly

not present in the seawater system of the C. N. ferries. Here, the heavy mussel fouling presented an interesting contrast to the M.S.R.L. The pipes of the C. N. ferries were rough iron and subject to lower water velocities and higher temperatures than those of the M.S.R.L. *Mytilus edulis*, the extremely dominant form in the pipes of the C.N. ferries, is also the biggest problem in most coastal power stations (Holmes 1970; Dobson 1946). Its productivity appears to increase when a slight current is present (Woods Hole Oceanographic Institute 1952). Yet, in the seawater system of the M.S.R.L., the mussel, although abundant, was not overwhelmingly dominant as in conduits of power stations and ships. Rather, dominance was shared or alternated with *Hiatella arctica* (e.g., in the horizontal pipes of Lab 213, *H. arctica* was dominant; in the reservoir outflow, *M. edulis* was dominant; in the horizontal pipe of Lab 218, *M. edulis* was more frequent in numbers, but *H. arctica* was dominant by mass and space occupied). It was noted that locally, *M. edulis* is very common in, and just below, the intertidal zone. *H. arctica* was seen in cracks of rocks and inside coralline algae, *Lithothamnion* sp. in the sub-tidal zone. It is quite common, and had been reported in many other fouling surveys (Long 1972; DePalma 1969; Haderlie 1971). An observation by Starostin (1963), during his examination of many technical water conduits, was the low species diversity of the pipe fouling community. This was also clearly visible in the C. N. ferries. Lin (1972) in a comparison of phytoplankton from Logy Bay and the M.S.R.L. pumphouse showed that intake



water contained plankton from the sand bottom and shoreline, as well as surface waters of Logy Bay. Thus the pipes would have received a variety of larval types. However, only 30 species were identified in the M.S.R.L. pipes. This was low, relative to the many animals found in Logy Bay. The lack of light, hard substrate, enclosed space, and constant current does not make the pipes a habitat for all animals. It was ideal for many sessile filter feeders such as bivalves, barnacles, tunicates and sponges, as were common.

One of the most important factors in the life of pipe fouling animals is the water flow and velocity. The flow of water through the pipes is anything but simple, depending on pipe diameter and roughness, water velocity and viscosity, and the presence of joints and curves which disrupt flow patterns. Water flow has not been constant since the marine lab started. Therefore, precise measurements would not be meaningful. However, in the main pipes supplying the whole lab, fluctuation in water demand of each separate lab would not be so noticeable. Therefore, the values obtained for these pipes may be regarded as close to average. Also, in a few of the labs, such as Lab 213, water flow has been quite constant.

It appears that the sessile animals which foul the M.S.R.L. pipe system were restricted within a range of water flows and velocities. Except for a slime film and few spirorbids, no fouling growth was observed in the 10.1 cm pipe from pump house to reservoir or the 10.1 cm vertical pipes of the main lab. Only in these pipes

and in the 10.1 cm pipe 'ring', was there any evidence of a maximum limiting velocity. In the 'ring' there was a gradual reduction in velocity, as each 5.1 cm vertical pipe branched off from the 'ring'. Corresponding to this velocity reduction was an increase in bivalve fouling, visible in the X-rays.

A look at water usage in some of the research labs (Table 4) shows the degree of fouling in various labs related to the flow rate and usage time (i.e., the more and longer the flow, the greater the fouling). It appears that productivity was increased as more optimum flows were experienced by the animals (Woods Hole Oceanographic Institute 1952). When the water flow became too low or intermittent, the fouling animals became scarce. Thus, water flow may be a reason for light fouling in the sea water system, as high water velocity limits settlement and stunts growth (Smith 1946), and minimum or intermittent flows kill whatever growth is present. This would require any succession to start all over again. The speed of current may also have contributed to the settlement pattern in the pipes. McDougall (1943) noted maximum settlement took place at that current speed optimum for growth of the species.

A more specific example of differences in fouling was observed in the removal and direct examination of two sections of pipe. The 5.1 cm horizontal Lab 213-3 season and Lab 218-3 season pipes were the same age, but had different flow rates -- Lab 213 having a more constant and higher flow than in Lab 218. This difference in flow

may be responsible for the differences in numbers of *Hiatella arctica*, *Mytilus edulis*, and *Molgula* sp. Although the mussel outnumbered *H. arctica* in the Lab 218 pipe, it was still less in mass due to its smaller size (see Table 6). The tunicate *Molgula* sp., abundant in Lab 218-3 season pipe was rare in the Lab 213-3 season pipe. Since these animals were also abundant in the Lab 213-1 season pipe, it was unlikely that the high flows restricted their settlement. It should be noted that both *Molgula* sp. and *Hiatella arctica* had a preference for the bottom of the pipe.

Throughout the seawater system are many different sizes and configurations of pipes which, acting in combination with water flows, produced some specific fouling patterns. Although some inconsistencies were noted, fouling in general appeared heavier in horizontal pipes than in corresponding vertical ones. Vertical pipes with water flow down, had less fouling than vertical up-flow pipes. It appeared that fouling was heavier in 5.1 cm pipes compared to 2.5 cm pipes in the same laboratory. The heaviest fouling was on the bottom rather than top of a horizontal pipe. The preference of some animals for the top or bottom location may have been a response to many factors, such as interspecific competition for space, genetic preference, air bubbles, mud deposits, gravity or flow patterns of water. *Mytilus edulis* was found more on the top of the pipe. This would agree with Bayne (1964) who found

that just prior to attachment *Mytilus edulis* larvae exhibit a negative geotaxis. Hunter (1949) likewise noted a similar action in *Hiatella arctica*. This was contrary to their preference in the pipes. Both *M. edulis* and *H. arctica* are quite active when small, and may move about for many months after settlement, thus changing their position in the pipe. Even quite large *M. edulis* were seen to move about somewhat by time lapse X-radiography.

Another interesting observation was the fouling pattern of the many valves, tees, elbows and other joints which caused a disruption of flow patterns setting up areas of low pressure, turbulence and eddies. An area which is in an eddy could offer some protection to animals in a zone of pipe which normally had limiting velocities. Where there is a joint, there is also a crevice or crack. Results from the tee joint X-rays and the transplanting of the young *H. arctica*, indicates a preference for the crevice location. This may have been due to a stimulus for settling in a groove (Hunter 1949). In contrast, the settlement of *Spirorbis spirillum* in the reservoir, exhibited no preference for the grooved side of the PVC panels. In open water, it was seen to settle everywhere on hard substrates.

The pump intake pipes and reservoir drainage pipe allowed water passage via perforations in the pipe wall. Both these sections of pipes were heavily fouled relative to adjacent pipe. The flow of water through the perforations was such, as to provide a site

more favourable for settlement and growth, as the pipe surface between each perforation was in an eddy. In the reservoir drain pipe, the fouling covered the entire inside surface and had grown in this manner a considerable distance inward and away from its original base.

Deposits of mud and pockets of air were observed in the pipes. The location of these, was governed by pipe configuration and water flow. Mud and debris may provide a source of food and shelter for some animals and suffocate others. Dead shells, flushed along the pipes, got caught along with other debris behind valves and in the stopcock valves, thus becoming a nuisance by constantly blocking water flow.

Bubbles of air trapped in high spots affected the animals through exposure and variations in water velocity. In localized positions, air pockets occupied some and often the major portion of the cross-sectional area of a pipe. Water velocities would thus have to increase proportionately to maintain a constant water flow past the air pocket. Furthermore, the bubbles were observed to move along the top of horizontal pipes in a scouring action.

True biotic succession has been described in several studies (Scheer 1945). However, it is often masked by seasonal succession in areas having large seasonal variations. Differences in the relative abundance of each species may occur from year to year (Coe & Allen 1937), further complicating the picture. Thus the

progression of the community must be followed closely for a number of years to gain a true picture of succession.

The initial settlement of a fouling community in the M.S.R.L. during the summer of 1971 was in some degree dependent on the time of year of immersion; however, similar results were obtained by the insertion and removal of various sections of PVC and acrylic pipes. The first life noticed was a slime film. Whether or not it was essential for further settlement in the M.S.R.L. pipes is unknown. A great deal of work has been done to determine the importance of the slime film (Horbund and Freiburger 1970). With few exceptions, larvae prefer a slime film to settle on, but it is not essential to settlement. After the slime film, patches of debris were seen to form in the pipes in July. This may have been adhering to young tunicates, which were visible a short time later. Associated with, and often connected to the tunicate, was the polychaete *Nicolea venustula*.

The fouling community after one year was dominated by *Molgula* sp. and *Nicolea venustula*. These new pipes used to observe settlement in 1971 yielded only a very few *Hiatella arctica*. However, in the Lab 213-4 season pipe the *H. arctica* settlement was heavy in 1971 and likewise in the Lab 213-3 season pipe in 1970. It therefore appears that *H. arctica* does not readily settle in a new pipe the first season and there is possibly succession from the *Molgula-Nicolea* to a *H. arctica* dominated community.

During 1971 a look at the settlement on the 6.5 month panels revealed large differences from the settlement in the pipes. On the panels, *Spirorbis spirillum* was dominant, with bryozoans also very common. These panels had collected more spirorbids and bryozoans in one season than the pipes had collected in four. Also of interest is the low settlement on the PVC panels exposed for three-week intervals (see Table 7), compared to the 6.5 month panels. One reason for this might be the time required for the development of a slime film on the panels. Knight-Jones (1951) found that a large percentage of *Spirorbis borealis* larvae did not undergo metamorphosis unless an algal film was present. Another cause of differences between the two panels could be the gregarious behavior of *Spirorbis* sp. (Knight-Jones 1951).

The measurements of *Hiatella arctica* length (Figure 16) may give some information on growth. Both graphs peak out at a size of 9 mm, which is the size of approximately 13.7% of the population. It seems likely that this peak represents the young of the year. This would be slightly larger than values given by DePalma (1969) on open water panels; however, in the pipes the current may have sped up growth. Note that very few animals were of maximum size and that this maximum size was 19 mm in Lab 213-3, and 21 mm in Lab 213-4. Less than 1.5% of the population in either pipe was 18 mm or over. The largest animals personally observed in local waters

were 30 mm. From the relatively low numbers of large animals found in the pipes, it appears that these larger, older bivalves, do not survive very well in the pipe environment. No predators of *Hiatella arctica* were found in the pipe. There were differences in actual numbers and dry weight of *H. arctica* in the Lab 213-3 and Lab 213-4 season pipes. However, this may simply be due to a productive summer in 1971. Such seasonal differences are to be expected.

Although only a quick look was made of the plankton, some interesting results were revealed. Counts were made of the dinoflagellate *Ceratium spp.* and the nauplius larvae because they were often in great abundance. Also, these animals were not likely to take up permanent residence in the pipe. In Figure 22 a large difference is noticeable between water entering the reservoir and water entering the lab. There are a couple of possible explanations to the reduction in numbers of plankton. Some of them may settle in the reservoir and pipes, or some may be eaten by the fouling animals in the pipes. Many of the animals are filter feeders and can remove large amounts of suspended matter. E.g., *Mytilus edulis* can filter 1.4 liters of water per hour (Thorson 1950). There is therefore a food loss between the incoming sea water containing fresh plant debris and plankton, and the lab wet benches which receive decaying debris, dead shells, animal faeces and less plankton.



Many inconsistencies and unexplainable observations occurred during the survey of the sea water system. One of the reasons for this is because the actual flow rates are unknown. The water flow is not constant, but rather, fluctuates to varying degrees, in different parts of the system. Another problem is that there is very little known about fouling in sea water pipes, or even about arctic water fouling. Therefore, there is very little information to which to refer. More study is definitely needed in this field.

## THE SEA WATER SYSTEM AT THE MARINE SCIENCES RESEARCH LABORATORY

### Problems

1. Intake water is drawn off very close to the shoreline, and as a result, debris and silt are also sucked up, especially during storms.

2. The pressure head of the reservoir will not supply water to the phycorium (deck 5) and is barely sufficient to supply the water demand of deck 4. The pressure problem will increase with the increasing water usage due to extension of M.S.R.L. facilities and with the restriction of water flow as the fouling increases.

3. Since intake water is coarse filtered only (minimum mesh size = 3 mm diameter), fouling is inevitable. The piping system is not designed to facilitate cleaning. Had fouling been as severe at the M.S.R.L. as at most other marine labs, then this system would have been rendered inoperative long ago.

The heaviest growth is present in the 15 cm outflow pipes from the reservoir, the back section of the 10.1 cm 'ring', the 5.1 cm horizontal pipes in many of the individual labs, and the 5.1 cm pipes supplying the loading dock area. All these pipes are inaccessible, except by cutting them out.

4. The silt, debris and loose bivalve shells tend to block valves which are not open full. Maintenance of a constant flow thus requires frequent readjustment. Shells which find their way into the 'A' frame pipes are usually too large to pass through the small stopcock valves.

### Suggestions

Fouling is relatively light at the M.S.R.L., therefore, drastic action need not be taken. However, the problems of fouling, pressure and debris should be kept under surveillance and appropriate action taken. Some suggestions are made.

1. Fouling.- X-rays should be made yearly (in the fall), to keep track of any changes in the status of fouling. X-rays should be at specific locations in the pipe system and include those areas known to be heavily fouled.

When the fouling growth is predicted to be hazardous to operation of the sea water system, then the necessary alterations should be made to provide for cleaning. If the fouling is localized, then the trouble spots could be changed. However, if the entire piping system is becoming fouled, then it should all be modified. In either case alterations might include: (a) the installation of accessible clean outs in each individual lab and loading dock area, (b) the development of a mechanical reamer to get at inaccessible areas, or else (c) replacement or duplication of these areas, (d) the installation of necessary valves and crossovers in the pipes from intake to reservoir to lab basement, such that there is an independent duplicate system, allowing stagnation and flushing of each system.

2. Pressure.- If necessary, the lack of head pressure may be partially corrected by the installation of more outflow pipes from the reservoir. Separate lines could be used so that each building or section of

building received adequate pressure.

Should the water demand ever increase greatly, then the sea water system would require a higher reservoir unit, more elevated than the old one, to provide more head pressure and hold a larger water supply for emergency shutdown periods.

3. Debris and Silt.- The use of a coarse filter to catch large debris, should be continued. A few minor modifications to make the reservoir a settlement basin, might also help. These would include raising the outfall pipe, so that it draws water from about mid-depth instead of the bottom and the construction of a baffle around the outflow pipe shielding it from the inflow.

4. Future Expansion.- It is recommended that all further construction of sea water system pipes be (a) exposed and accessible, (b) consist of as many straight runs as possible with two way access clean outs at each corner, such as 'X's, (c) have shut off valves to isolate each section, (d) be in duplicate if possible and especially if constant water flow is needed at all times, (e) consist of materials which are opaque and non-toxic such as poly-vinyl chloride (PVC).

## SUMMARY

An operative description and a survey of fouling was made of the poly-vinyl chloride (PVC) sea water system of the Marine Sciences Research Laboratory, Logy Bay, Newfoundland. This was done by means of x-radiography and direct examination.

After four years continuous use, the marine growth present was not sufficient to retard operation of the system; however, it was a nuisance.

The piping system itself, was not designed to facilitate cleaning. Suggestions are made for a course of action.

Deposits of mud and pockets of air were observed in various locations. These could affect the fouling animals directly and also the water flow through the pipes.

The settlement season in the sea water system was estimated to be slightly over four months, being mainly dependent on temperature.

In general, fouling appeared to be (a) heavier in 5.1 cm pipes compared to 2.5 cm pipes of the same lab, (b) heavier in horizontal pipes than corresponding vertical ones, and (c) heavier in vertical pipes with water flowing up, than in vertical down-flow pipes.

Fouling appeared to be restricted within a range of maximum and minimum water flows and velocities.

Where velocity was not limiting, the productivity of the fouling organisms was related to the flow rate and time.

Bivalves were more abundant on the joint or crack of a fitting, relative to the adjacent surface.

Pipes having perforations through their walls to allow water passage were more heavily fouled, relative to the adjacent pipe.

The communities in 5.1 cm horizontal pipes, having had a flow time of one to four summer seasons, were studied in detail.

Of the 30 species of foulers identified in the pipes, the bivalves *Hiatella arctica* and *Mytilus edulis* constituted the greatest mass; however, *Molgula* sp., *Leucosolenia* sp., *Spirorbis spirillum*, *Anomia simplex* and *Balanus* spp. were also common.

Differences in the relative abundance of *H. arctica*, *M. edulis* and *Molgula* sp., were observed in identical pipes with different flow rates.

Measurements of *H. arctica* show a mode value for the young of the year at a length of 9 mm. Very few animals (less than 1.5 per cent) grew over 18 mm in length.

By use of acrylic tubing and PVC inserts, the initial settlement of a fouling community during the summer season of 1971 was described for a horizontal 5.1 cm pipe.

A fungal-bacterial slime was the first life form. The primary dominant macro-foulers after one year were *Molgula* sp. and *Nicolea venustula*.

In older pipes, *H. arctica* was usually the dominant form.

A partial season of settlement was established for *S. spirillum*, on PVC panels hung in the reservoir. No significant difference was found for settlement between the rough and smooth side of the panels.

An examination of water entering the reservoir and Lab 213 showed Lab 213 receiving less plankton and more debris.

## LIST OF REFERENCES

- Bayne, B. L. 1964. The response of the larvae of *Mytilus edulis* L. to light and gravity. *Oikos* 15(1):162-174.
- Bayne, B. L. 1969. The gregarious behaviour of the larvae of *Ostrea edulis* L. at settlement. *J. Mar. Biol. Assoc. U.K.* 49(2):327-356.
- Bousfield, E. L. 1960. Canadian Atlantic sea shells. National Museum of Canada, Ottawa. 72 p.
- Coe, W. R., and W. E. Allen. 1937. Growth of sedentary organisms on experimental blocks and plates for nine years at Scripps pier. *Bull. Scripps Inst. Oceanogr. Tech. Ser.* 4(4):101-136.
- Coulson, J. M., and J. F. Richardson. 1964. *Chemical Engineering, Volume one.* Macmillan Co., New York. 492 p.
- Crisp, D. J. 1953. Changes in orientation of barnacles of certain species in relation to water currents. *J. Animal Ecol.* 22:331-343.
- Crisp, D. J., and H. Barnes. 1954. The orientation and distribution of barnacles at settlement with particular references to surface contour. *J. Animal Ecol.* 23:142-162.
- Crisp, D. J. 1955. The behavior of barnacle cyprids in relation to water movement over a surface. *J. Exp. Biol.* 32:569-590.
- Crisp, D. J., and J. S. Ryland. 1960. Influence of filming and of surface texture on the settlement of marine organisms. *Nature.* 185:119.
- Davis, D. S., and W. R. White. 1966. Molluscs from a power station culvert. *J. Conchology.* 26:33-38.
- DePalma, J. 1969. Marine biofouling at Penobscot Bay, Maine and Placentia Sound, Newfoundland. Informal Report No. IR 69-56, U.S. Naval Oceanographic Office, Wash. D.C. 14 p.
- Dobson, J. G. 1946. The control of fouling organisms in fresh and salt water circuits. *A.S.M.E., Trans.* 68:247-265.



- Fox, D. L., and W. R. Coe. 1943. Biology of the California sea mussel *Mytilus californianus*. II Nutrition, metabolism, growth and calcium deposition. J. Exp. Zool. 93:205-249.
- Glaus, K. J. 1968. Factors affecting the production of byssus threads in *Mytilus edulis*. Biol. Bull. 135:420.
- Gosner, K. L. 1971. Guide to Identification of Marine and Estuarine Invertebrates. John Wiley and Sons Inc., New York. 693 p.
- Gutsell, J. S. 1930. Natural history of the bay scallop. Bull. U. S. Bur. Fish. 46:569-632.
- Haderlie, E. C. 1971. Marine fouling and boring organisms at 100 foot depth in open water of Monterey Bay. The Veliger. 13 (3):249-260.
- Henke, R. W. 1966. Introduction to Fluid Mechanics. Addison-Wesley Publ. Co., U.S.A. 232 p.
- Hentschel, E. 1923. Der Berwuchs an Seeschiffen. Int. Rev. Hydrobiol. Hydrogr. 11:238-264.
- Holmes, N. 1970. Mussel fouling in chlorinated cooling systems. Chem. and Industry, 1970. 1244-1247 p.
- Horbund, H. M., and A. Freiberger. 1970. Slime films and their role in marine fouling: A Review. Ocean Eng. 1(6):631-634.
- Hunter, W. R. 1949. The structure and behaviour of *Hiatella gallicana* Lamark and *H. arctica* with special reference to the boring habit. Roy. Soc. (Edinburgh), Proc., Sec. B. 63(3):271-289.
- Hutchins, L. W., and E. S. Deevey Jr. 1944. Estimation and prediction of the weight and thickness of mussel fouling on buoys. Interim Report I for 1944 from Woods Hole Oceanogr. Inst. to Bureau of Ships (Unpublished).
- Igic, L. 1968. The fouling on ships as the consequence of their navigation in the Adriatic and other world seas. Paper presented at the Second International Congress on Marine Corrosion and Fouling. Athens, Greece. September 20-24, 1968.
- Kawahara, T. 1962. Studies on marine fouling communities. Part I. Report of Faculty of Fisheries, Prefectural University of Mie. 4(2):27-45.

- Knight-Jones, E. W. 1951. Gregariousness and some other aspects of the settling behaviour of *Spirorbis*. J. Mar. Biol. Assoc. 30:201-222.
- Knight-Jones, W. W., and J. Moyses. 1961. Intraspecific competition in sedentary marine animals. Symp. Soc. Exp. Biol. 15:72-95.
- Kujawa, S. 1968. The phenology of fouling organisms in the Southern Baltic. Paper presented at the Second International Congress on Marine Corrosion and Fouling. Athens, Greece. September 20-24, 1968.
- Li, W. H., and S. H. Lam. 1964. Principles of Fluid Mechanics. Addison-Wesley Publ. Co., U.S.A. 374 p.
- Lin, Yi-Hung. 1972. An annual cycle of phytoplankton, with special reference to the diatoms and armored dinoflagellates of Logy and Robin Hood Bays, Avalon Peninsula, Newfoundland. February 1970 - January 1971. Unpublished Master of Science thesis, Memorial University of Newfoundland, St. John's, Newfoundland, March 1972.
- Long, E. R. 1972. Studies of marine fouling and boring off Kodiak Island, Alaska. Marine Biology. 14(1):52-57.
- McDougall, K. D. 1943. Sessile marine invertebrates of Beaufort, North Carolina: A study of growth, settlement and seasonal fluctuations among pile dwelling organisms. Ecol. Monographs. 13(3):321-374.
- Meadows, P. S., and G. B. Williams. 1963. Settlement of *Spirorbis borealis* Daudin larvae on surfaces bearing films of micro-organisms. Nature. 198:610-611.
- Millar, R. H. 1966. Marine Invertebrates of Scandinavia. Number 1, Tunicata, Ascidiacea. Scandinavian Univ. Books, Oslo. 123 p.
- Miner, R. W. 1950. Field Book of Seashore Life. G. P. Putnam's Sons, New York. 888 p.
- Organization for Economic Co-operation and Development. 1965. Catalogue of Main Marine Fouling Organisms. Vol. 2; Polyzoa. Paris. 83 p.

- Pastula, E. J. 1970. World atlas of coastal biological fouling. Part I; North America, South America, Iceland and Greenland. Informal Report No. 70-51, U.S. Naval Oceanographic Office, Wash., D.C. 81 p.
- Pettibone, M. H. 1963. Marine Polychaete Worms of the New England Region, Part I. U.S. Natural Museum Bull. 227. 356 p.
- Pomerat, C. M., and E. R. Reiner. 1942. The influence of surface angle and light on the attachment of barnacles and other sedentary organism. Biol. Bull. 82(1):14-25.
- Pomerat, C. M., and C. M. Weiss. 1946. The influence of texture and composition of surface on the attachment of sedentary marine organisms. Biol. Bull. 91(1):57-65.
- Powell, N. A. 1968. Bryozoa polyzoa of Arctic Canada. J. Fish. Res. Bd. Canada. 25(11):2269-2320.
- Scheer, B. T. 1945. The development of marine fouling communities. Biol. Bull. 89:103-121.
- Second International Congress on Marine Corrosion and Fouling. Athens, Greece. September 20-24, 1968.
- Smith, F. G. W. 1946. Effect of water currents upon the attachment and growth of barnacles. Biol. Bull. 90(1):51-70.
- Smith, R. I., ed. 1964. Key to Marine Invertebrates of the Woods Hole Region. Contribution No. 11, Mar. Biol. Lab., Woods Hole, Mass. 208 p.
- Sprague, J. B. 1966. Filtration of sea-water for marine biological laboratories. Fish. Res. Bd. Canada, MS Rept. (Biol.) No. 851. 22 p.
- Starostin, I. V., ed. 1963. Marine Fouling and Borers. Trudy Instituta Okeanologii, Vol. LXX, U.S. Naval Oceanographic Office Translation No. 221, 1964-1965.
- Sutherland, P. 1967. Use of electrolytic cells to prevent marine infestations at coastal power stations. Inst. of Elec. Engr. Quart. 38:52-58.
- Thorson, G. 1950. Reproductive and larval ecology of marine bottom invertebrates. Biol. Review. 25:1-45.

- Thorson, G. 1957. Bottom communities. in Treatise on Marine Ecology and Paleocology, J. W. Hedgepeth, ed., Vol. 1, Ecology. Geol. Soc. Amer. Memoir. 67:461-534.
- Thorson, G. 1964. Light as an ecological factor in the dispersal and settlement of larvae of marine bottom invertebrates. *Ophelia*. 1(1):167-208.
- Visscher, J. P. 1928. Nature and extent of fouling of ships' bottoms. *Bull. Bur. Fish.* 43(2):193-252.
- White, H. E. 1950. Control of marine fouling in seawater conduits including exploratory tests on killed shelled mussels. *A.S.M.E., Tran.* 72(2):117-126.
- Woods Hole Oceanographic Institute. 1952. Marine Fouling and its prevential. U.S. Naval Institute, Annapolis. 388 p.
- Zobell, C. E., and E. C. Allen. 1935. The significance of marine bacteria in the fouling of submerged surfaces. *J. Bacteriology*. 29:239-251.

## APPENDIX I

## Frequency of Animals in 5.1 cm Horizontal Pipe

Genus species	Location in Pipe	Location			
		L213-1	L213-3	L213-4	L218-3
<i>Hiatella arctica</i>	Top	-	142	134	20
	Bottom	3	481	594	62
	Total	3	623	728	82
<i>Mytilus edulis</i>	Top	8	247	387	320
	Bottom	9	101	137	107
	Total	17	348	524	427
<i>Anomia simplex</i>	Top	-	4	2	4
	Bottom	-	6	5	15
	Total	-	10	7	19
<i>Balanus spp.</i>	Top	-	8	14	7
	Bottom	-	33	31	17
	Total	-	41	45	24
<i>Molgula sp.</i>	Top	1	10	6	33
	Bottom	74	9	1	180
	Total	75	19	7	213
<i>Nicolea venustula</i>	Total	16	?	11	38
<i>Nereis pelagica</i>	Total	-	11	19	18
<i>Lepidonotus squamatus</i>	Total	-	2	4	25

## APPENDIX II

Dry Weight in Grams of *Hiatella arctica* and *Mytilus edulis* per Meter of 5.1 cm Horizontal Pipe

		Pipe		
		L218-3	L213-3	L213-4
<i>Hiatella arctica</i>	Top	.91	9.43	12.52
	Bottom	3.21	37.88	59.32
	Total	4.12	47.31	71.84
<i>Mytilus edulis</i>	Top	1.76	1.87	6.66
	Bottom	.55	1.35	2.75
	Total	2.31	3.22	9.41

APPENDIX III

Number of *Hiatella arctica* in Each Size Class on  
the Top and Bottom of Horizontal 5.1 cm Pipes

Length in mm (Class Boundary)	Class Markers	L213-3 Season Pipe			L213-4 Season Pipe			L218-3 Season Pipe		
		Top	Bottom	Total	Top	Bottom	Total	Top	Bottom	Total
1.5 - 2.49	2	2	0	2	2	1	3	-	1	1
2.5 - 3.49	3	5	3	8	5	4	9	-	1	1
3.5 - 4.49	4	27	5	32	2	15	17	3	1	4
4.5 - 5.49	5	45	16	61	8	37	45	1	9	10
5.5 - 6.49	6	64	28	92	21	54	75	7	7	14
6.5 - 7.49	7	74	29	103	16	96	112	3	10	13
7.5 - 8.49	8	87	29	116	28	106	134	3	11	14
8.5 - 9.49	9	109	35	144	28	158	186	6	17	23
9.5 - 10.49	10	86	21	107	28	133	161	3	20	23
10.5 - 11.49	11	69	17	86	29	108	137	4	16	20
11.5 - 12.49	12	66	17	83	20	106	126	4	9	13
12.5 - 13.49	13	56	17	73	21	87	108	2	3	5
13.5 - 14.49	14	44	6	50	15	74	89	-	2	2
14.5 - 15.49	15	38	14	52	11	44	56	-	-	-
15.5 - 16.49	16	14	1	15	11	47	58	-	-	-
16.5 - 17.49	17	9	4	13	3	23	26	-	-	-
17.5 - 18.49	18	5	1	6	5	10	15	-	-	-
18.5 - 19.49	19	1	1	2	-	4	4	-	-	-
19.5 - 20.49	20	-	-	-	-	4	4	-	-	-
20.5 - 21.49	21	-	-	-	-	2	2	-	-	-

APPENDIX IV

Number of *Spirorbis spirillum* Settled  
on Poly-Vinyl Chloride Panels 1971

(a) Large Panels (17 X 30 cm) 1 Side Only

Immersion Time	Panel 1	Panel 2	Panel 3	Panel 4	Panel 5
June 1 - June 22	513	500	405	206	173
June 22 - July 13	780	500	360	210	257

(b) Small Panels (5 X 15 cm)

Immersion Time	Panel 1		Panel 2		Panel 3		Panel 4		Panel 5	
	Smooth Side	Rough Side	Smooth Side	Rough Side	Smooth Side	Rough Side	Smooth Side	Rough Side	Smooth Side	Rough Side
July 13 - Aug. 3	37	32	11	33	11	30	9	12	7	18
Aug. 3 - Aug. 24	23	49	20	19	25	24	11	44	38	16
Aug. 24 - Sept. 14	97	68	52	34	77	66	17	28	27	36
Sept. 14 - Oct. 4	27	61	46	54	29	30	25	24	8	25
Oct. 4 - Oct. 18	26	22	9	18	10	27	17	16	20	24
Oct. 18 - Nov. 8	16	14	20	21	22	16	16	7	9	18
Nov. 8 - Nov. 26	6	19	6	8	1	6	4	4	3	2
Nov. 28 - Dec. 19	2	1	1	0	1	0	1	3	1	1



## APPENDIX V

Number of *Ceratium spp.* and Nauplius Larvae per 57 Liter  
Sample from Sampling Stations Lab 213 and Reservoir Inflow

Date of Sample	Station	Number of <i>Ceratium spp.</i>	Number of Nauplius Larvae
August 16, 1971	L213	47	2
	Res.	1000	180
August 26	L213	75	10
	Res.	425	165
September 24	L213	0	0
	Res.	0	7
October 7	L213	8	0
	Res.	18	5
October 27	L213	17	0
	Res.	124	0
November 11	L213	14	0
	Res.	30	0





