

MERCURY CONCENTRATION IN FISH AS A FUNCTION
OF CHANGE IN RESERVOIR SIZE

CENTRE FOR NEWFOUNDLAND STUDIES

**TOTAL OF 10 PAGES ONLY
MAY BE XEROXED**

(Without Author's Permission)

THOMAS WAYNE THERRIault



Mercury Concentration in Fish as a Function of
Change in Reservoir Size

Thomas Wayne Therriault

A thesis submitted to the School of Graduate Studies
in partial fulfilment of the requirements for the
degree of Master of Science (Biology)

Department of Biology
Memorial University of Newfoundland
St. John's, Newfoundland

1996



National Library
of Canada

Acquisitions and
Bibliographic Services Branch

395 Wellington Street
Ottawa, Ontario
K1A 0N4

Bibliothèque nationale
du Canada

Direction des acquisitions et
des services bibliographiques

395, rue Wellington
Ottawa (Ontario)
K1A 0N4

Your file *Votre référence*

Our file *Notre référence*

The author has granted an irrevocable non-exclusive licence allowing the National Library of Canada to reproduce, loan, distribute or sell copies of his/her thesis by any means and in any form or format, making this thesis available to interested persons.

L'auteur a accordé une licence irrévocable et non exclusive permettant à la Bibliothèque nationale du Canada de reproduire, prêter, distribuer ou vendre des copies de sa thèse de quelque manière et sous quelque forme que ce soit pour mettre des exemplaires de cette thèse à la disposition des personnes intéressées.

The author retains ownership of the copyright in his/her thesis. Neither the thesis nor substantial extracts from it may be printed or otherwise reproduced without his/her permission.

L'auteur conserve la propriété du droit d'auteur qui protège sa thèse. Ni la thèse ni des extraits substantiels de celle-ci ne doivent être imprimés ou autrement reproduits sans son autorisation.

ISBN 0-612-13953-0

Canada

ABSTRACT

Increased fish mercury concentrations are often observed following impoundment of a reservoir. Following impoundment, there is a flux of organic matter and nutrients from the flooded soil, providing food to bacterial communities which methylate inorganic mercury. Based on the hypothesis that mercury enters a reservoir via the flooded soil, I investigated whether the change in fish mercury concentrations could be predicted from the change in reservoir size. Mercury monitoring data for three fish species, northern pike (*Esox lucius*), walleye (*Stizostedion vitreum*), and lake whitefish (*Coregonus clupeaformis*) from reservoirs in northern Manitoba and northern Quebec were used to derive parameter estimates for four models. Models were evaluated on their ability to predict cases not used in the model development. Models were applied for predictive purposes to assess the impact of creating a reservoir and to assess the impact of altering the size of an existing reservoir. Skill (closeness of predicted and observed values) and explained variance were also used to assess the models. The preferred models consisted of a single enrichment term (a measure of change in flooded area) that successfully predicted the mercury ratio. This study also demonstrated that parameter estimates for one species could be applied successfully to predict the mercury ratio for species with comparable food habits.

ACKNOWLEDGEMENTS

To David Schneider, my supervisor, none of this would have been possible without his guidance. I would also like to thank him for financial support that allowed me to attend the ASLO/PSA Joint Meeting in Miami, Florida and the Conference on Mercury as a Global Pollutant in Whistler, British Columbia. These conferences were a valuable learning experience.

My committee members, Chris Parrish and Roy Kuoehel, whose insight aided in the preparation of this thesis.

Data used for the development and evaluation of the models in this study were released, and provided by, a number of people. David Windsor of Manitoba Hydro agreed to release data collected from Manitoba reservoirs. Drew Bodaly from the Department of Fisheries and Oceans, Central Region, kindly provided data for reservoirs impounded as part of the Southern Indian Lake/Churchill River Diversion Project in northern Manitoba. Tom Johnston, also from Fisheries and Oceans, provided the fish mercury data from control lakes that were used to determine preimpoundment fish mercury concentrations for the Manitoba reservoirs. Don Steel from North/South Consultants Inc. also provided data for other Manitoba reservoirs. Claude Langlois from Hydro Quebec agreed to release fish mercury data collected in conjunction with monitoring efforts in the La Grande Complex in northern Quebec. Julie Sbogen provided background information while Francois Doyon of Groupe Environnement Shoener inc.

provided the raw data for La Grande Complex reservoirs in addition to fish mercury data collected from control lakes in and around the La Grande Complex. These fish mercury concentrations were used to determine preimpoundment mercury concentrations for La Grande Complex reservoirs. Data used for the Newfoundland predictions were provided by Ed Hill and Larry LeDrew from Newfoundland and Labrador Hydro and Dave Scruton from the Department of Fisheries and Oceans, Newfoundland Region. Due to time constraints governing the submission of this thesis, fish mercury data collected for reservoirs impounded in British Columbia, provided by Tom Watson of Triton Environmental Group (formerly with B.C. Hydro) was not used. However, I would like to thank him for his time and efforts.

To all NICOSians, both past and present, who made work bearable, if not enjoyable, for the two years necessary to complete this thesis. A special thanks to Lynn Bussey who aided in the preparation of the appendix and the three W.I.S.E. students, Hilary Baikie, Tara Martin, and Shanna O'Reilly, who assisted in the preparation of maps presented in this thesis.

To Jen, who provided me with continual support and encouragement.

TABLE OF CONTENTS

Abstract	ii
Acknowledgements	iii
Table of Contents	v
List of Tables	viii
List of Figures	ix
1.0 Introduction	1
2.0 Background	
2.1 Mercury Chemistry	2
2.2 Toxicology	3
2.3 Remediation	6
2.4 Biogeochemistry	8
2.5 Methylation	10
2.6 Bioaccumulation and Biomagnification	12
2.7 Autogenic Mercury Loading	18
3.0 Effects of Reservoir Impoundment	21
4.0 Model Development	34
4.1 Model Evaluation	39

5.0	Methods and Materials	
5.1	Location of Reservoirs Used in this Study	41
5.1.1	Southern Indian Lake/Churchill River Diversion Project -- Northern Manitoba	43
5.1.2	La Grande Complex -- Northern Quebec	49
5.1.3	Newfoundland	53
5.1.4	Summary	56
5.2	Mercury Data Used in the Analyses	57
5.3	Model Validation	59
5.3.1	Definition of the Response Variable	59
5.3.2	Validation Procedure	60
5.4	Application of the Models -- Newfoundland Predictions	61
5.4.1	Different Species -- Cat Arm Salmonids	61
5.4.2	Different Reservoirs -- The Long Pond Prediction	63
6.0	Available Data on Fish Mercury Concentrations	65
6.1	Manitoba	65
6.2	Quebec	67
6.3	Newfoundland	69
7.0	Results	
7.1	The Models	87
7.1.1	Model I (Equation 12)	87
7.1.2	Model II (Equation 13)	90
7.2	Equations with Parameter Estimates -- Model I and II (Equations 12 and 13)	93
7.3	Newfoundland Predictions	98
7.3.1	Different Species -- Cat Arm Salmonids	98
7.3.2	Different Reservoirs -- The Long Pond Prediction	99
7.4	Revision of Model I and II	100
7.5	The Revised Models	101
7.5.1	Model III (Equation 50)	101
7.5.2	Model IV (Equation 51)	104
7.6	Equations with Parameter Estimates -- Model III and IV (Equations 50 and 51)	107
7.7	Newfoundland Predictions Using Model III and IV	113

7.7.1	Different Species -- Cat Arm Salmonids	113
7.7.2	Different Reservoirs -- The Long Pond Prediction	114
8.0 Discussion		
8.1	Model I, II, III, IV (Equations 12, 13, 50, 51)	152
8.1.1	Model I	152
8.1.2	Model II	154
8.1.3	Model III	155
8.1.4	Model IV	157
8.1.5	Comparison of the Four Models	158
8.2	Sources for Improvement	160
8.3	Applications	164
Literature Cited		165
Appendix A: Raw Data for Mercury in Fish		220

LIST OF TABLES

Table		Page
1	Comparison of morphometric, hydrologic, limnological, and biological factors for four Southern Indian Lake regions before and after impoundment	46
2	Changes in water level and surface area of several lakes affected by the Churchill River Diversion Project	48
3	Characteristics of La Grande Complex Reservoirs	51
4	Characteristics of Reservoirs and Control Lakes in Newfoundland	55

LIST OF FIGURES

Figure		Page
1	The mercury cycle	10
2	Location of the three main areas of study	42
3	Location of reservoirs impounded as a result of the Southern Indian Lake/Churchill River Diversion Project	47
4	Location of reservoirs impounded in the La Grande Complex located in northern Quebec	52
5	Location of Cat Arm Reservoir	56
6	Mean mercury concentrations of northern pike sampled from lakes impounded as part of the Southern Indian Lake/Churchill River Diversion Project	71
7	Mean mercury concentration of northern pike sampled from lakes impounded as part of Notigi Reservoir	72
8	Mean mercury concentrations of walleye sampled from lakes impounded as part of the Southern Indian Lake/Churchill River Diversion Project	73
9	Mean mercury concentrations of walleye sampled from lakes impounded as part of Notigi Reservoir	74
10	Mean mercury concentrations of lake whitefish sampled from lakes impounded as part of the Southern Indian Lake/Churchill River Diversion Project	75
11	Mean mercury concentrations of lake whitefish sampled from lakes impounded as part of Notigi Reservoir	76
12	Mean mercury concentrations of northern pike sampled from La Grande Complex reservoirs	77

Figure	Page
13 Mean mercury concentrations of walleye sampled from La Grande Complex reservoirs	78
14 Mean mercury concentrations of lake whitefish sampled from La Grande Complex reservoirs	79
15 Plots of mean mercury concentrations for northern pike, walleye and lake whitefish for Caniapiscau; La Grande 2; La Grande 3; La Grande 4; and Opinaca Reservoirs	80
16 Mean mercury concentrations plotted against reservoir age for northern pike, walleye and lake whitefish for Caniapiscau; La Grande 2; La Grande 3; La Grande 4; and Opinaca Reservoirs	81
17 Mean mercury concentrations of Arctic char and brook trout sampled in Cat Arm Reservoir	82
18 Mercury concentrations plotted against fork length, by year, for Arctic char sampled at Cat Arm Reservoir	83
19 Mercury concentrations plotted against fork length, by year, for brook trout sampled at Cat Arm Reservoir	84
20 Mercury concentrations plotted against weight, by year, for Arctic char sampled at Cat Arm Reservoir	85
21 Mercury concentrations plotted against weight, by year, for brook trout sampled at Cat Arm Reservoir	86
22 Predicted and observed values of the mercury ratio for northern pike for Model I	115
23 Predicted and observed values of the mercury ratio for walleye for Model I	116
24 Predicted and observed values of the mercury ratio for lake whitefish for Model I	117

Figure	Page
25 Explained variance of Model I for northern pike, walleye, and lake whitefish plotted by reservoir	118
26 Explained variance of Model I for northern pike, walleye, and lake whitefish plotted by region	119
27 Predicted and observed values of the natural logarithm of the mercury ratio for northern pike using Model II	120
28 Predicted and observed values of the natural logarithm of the mercury ratio for walleye using Model II	121
29 Predicted and observed values of the natural logarithm of the mercury ratio for lake whitefish using Model II	122
30 Explained variance of Model II for northern pike, walleye, and lake whitefish plotted by reservoir	123
31 Explained variance of Model II for northern pike, walleye, and lake whitefish plotted by region	124
32 Predicted and observed values of the mercury ratio for brook trout in Cat Arm Reservoir using Model I	125
33 Predicted and observed values of the mercury ratio for Arctic char in Cat Arm Reservoir using Model I	126
34 Predicted and observed values of the natural logarithm of the mercury ratio for brook trout in Cat Arm using Model II	127
35 Predicted and observed values of the natural logarithm of the mercury ratio for Arctic char in Cat Arm using Model II	128
36 Mean mercury concentrations of ouananiche and brook trout sampled in Long Pond after reimpoundment	129
37 Predicted and observed values of the mercury ratio for Long Pond brook trout using Model I	130

Figure	Page
38 Predicted and observed values of the mercury ratio for Long Pond ouananiche using Model I	131
39 Predicted and observed values of the natural logarithm of the mercury ratio for Long Pond brook trout using Model II	132
40 Predicted and observed values of the natural logarithm of the mercury ratio for Long Pond ouananiche using Model II	133
41 Predicted and observed values of the mercury ratio for northern pike for Model III	134
42 Predicted and observed values of the mercury ratio for walleye for Model III	135
43 Predicted and observed values of the mercury ratio for lake whitefish for Model III	136
44 Explained variance of Model III for northern pike, walleye, and lake whitefish plotted by reservoir	137
45 Explained variance of Model III for northern pike, walleye, and lake whitefish plotted by region	138
46 Predicted and observed values of the natural logarithm of the mercury ratio for northern pike for Model IV	139
47 Predicted and observed values of the natural logarithm of the mercury ratio for walleye for Model IV	140
48 Predicted and observed values of the natural logarithm of the mercury ratio for lake whitefish for Model IV	141
49 Explained variance of Model IV for northern pike, walleye, and lake whitefish plotted by reservoir	142
50 Explained variance of Model IV for northern pike, walleye, and lake whitefish plotted by region	143

Figure	Page
51 Predicted and observed values of the mercury ratio for brook trout in Cat Arm Reservoir using Model III	144
52 Predicted and observed values of the mercury ratio for Arctic char in Cat Arm Reservoir using Model III	145
53 Predicted and observed values of the natural logarithm of the mercury ratio for brook trout in Cat Arm using Model IV	146
54 Predicted and observed values of the natural logarithm of the mercury ratio for Arctic char in Cat Arm using Model IV	147
55 Predicted and observed values of the mercury ratio for Long Pond brook trout using Model III	148
56 Predicted and observed values of the mercury ratio for Long Pond ouananiche using Model III	149
57 Predicted and observed values of the natural logarithm of the mercury ratio for Long Pond brook trout using Model IV	150
58 Predicted and observed values of the natural logarithm of the mercury ratio for Long Pond ouananiche using Model IV	151

1.0 INTRODUCTION

Mercury and mercury compounds have received a great deal of attention over the last two decades because of environmental and health concerns. Methylmercury poisoning can be lethal to humans and wildlife. Historically, mercury contamination has been associated with sources of industrial or agricultural pollution. More recently it has been linked to natural phenomena. Because of these health concerns, mercury concentrations need to be monitored as well as modeled. Before quantitative models are developed, the system being modeled must be understood as completely as possible, including the nature of and relation between biological, chemical, and geological components.

The models developed later in this thesis are based on a biological understanding of processes affecting fish mercury concentrations following reservoir impoundment. Before the models were developed, a review of the literature was undertaken. This included general background information about mercury chemistry (Section 2.0) and the effects of reservoir impoundment (Section 3.0). A detailed development of two models is presented in Section 4.0. The location of reservoirs used in this study, the data used in the analyses, the validation procedure and the application of the models are presented in Section 5.0. Data available for this study are presented in Section 6.0. Results from this study are presented in Section 7.0 and discussed in Section 8.0.

2.0 BACKGROUND

2.1 Mercury Chemistry

Mercury is ubiquitous, mostly in trace amounts (Huckabee *et al.*, 1978). Mercury is a group IIB heavy metal with oxidation states 2 and 1, an atomic number 80, and atomic weight 200.59. It is highly volatile, a liquid at room temperature, and certain compounds can be toxic. In water, mercurial ions are generally associated with chloride ions (Cl^-) or hydroxide ions (OH^-). The mercuric ion (Hg^{2+}) is a typical class "b" acceptor (Ahrland, 1966; Pearson, 1968a, 1968b) and readily forms covalent compounds, preferring sulfur (S) and selenium (Se) donor atoms (Ramamoorthy and Blumhagen, 1984). In nature it occurs predominately in its sulfide form, cinnabar (HgS), which can be mined and roasted to yield metallic mercury (Bligh, 1970). It is introduced to the environment through fumaroles, hot springs, magmatic sources (Siegel and Siegel, 1975), and as a result of evaporation from the earth's crust. It is then distributed by aerial circulation and precipitation (Stoch and Cucuel, 1934).

The same properties that make mercury a unique element also make it very economically valuable. Mercury has been used since the time of the Roman Empire, and its compounds are found in cosmetics, medicinal treatments, dental amalgams, paints, electrical equipment, thermometers, and batteries (Fitzgerald and Clarkson,

1991). At one time, mercury was used extensively in the recovery of gold and silver from ore. This use has been declining for years (Bligh, 1970), with the notable exception of the Amazon region of Brazil. Following World War II the industrial use of mercury increased, primarily because of chlor-alkali plants and electrical industries (Bligh, 1970). The pulp and paper industry used organic mercurials such as phenylmercuric acetate as slimicides to prevent fouling of mill equipment (Bligh, 1970; Nuorteva *et al.*, 1979; Lodenius, 1991). Ethylmercury phosphate has been used for the treatment of bacterial infections in hatchery fish and has led to increased body burdens of mercury in these fish (Rucker and Amend, 1969). The major fluxes of mercury into the atmosphere can be linked to oil and coal combustion, incineration of solid wastes, and smelting processes associated with the production of copper and zinc (Nriagu and Pacyna, 1988).

2.2 Toxicology

Despite the widespread use of mercury and mercury compounds, the severity of mercury poisoning was not realized until the late 1950's at Minimata Bay, Japan where 111 documented casualties occurred from the consumption of fish and shellfish contaminated by mercury (Lofroth, 1969). The toxic agents were found to be methylmercury compounds originating from chemical plants using mercury-based

catalysts; either mercuric oxide in preparation of acetaldehyde or mercuric chloride in preparation of vinyl chloride (Bligh, 1970). Following the Minimata disaster, and due to concerns for human welfare, mercury became a closely monitored substance. Canada, along with many countries around the world, has imposed restrictions regulating mercury consumption by humans (Royal Society of Canada, 1971).

The concern about elevated fish mercury levels is due to the propensity of fish to accumulate mercury, thus producing a potential hazard to humans if consumed (Nriagu, 1979). At present, the most effective indicator of both the degree of mercury pollution and the potential hazards to humans and wildlife is the mercury content of fish. Crayfish are also good indicators of mercury contamination in various water bodies (Vermeer, 1972). Elevated levels of inorganic mercury and methylmercury in humans have been linked to fish consumption (Berglund *et al.*, 1971; Suzu'ki *et al.*, 1971; Yamaguchi *et al.*, 1971). Simpson *et al.* (1974) showed that fish is man's primary exposure pathway to mercury; the consumption of fish and fish products is essentially the only pathway for human exposure to methylmercury (World Health Organization, 1976). Researchers in Finland found mercury concentrations of up to 35 ppm in the hair of people consuming fish from Finnish reservoirs (Lodenius *et al.*, 1983; Alftan *et al.*, 1983). Native people consuming fish from Ball Lake (Wabigoon-English-Winnipeg River System) and other polluted lakes are known to have elevated blood-mercury levels (Anon., 1973).

Many governments have imposed restrictions on mercury contaminated fish.

In Sweden, areas where fish are caught with mercury levels greater than 1.0 ppm are "black-listed" (Björklund *et al.*, 1984). These fish cannot be sold or distributed for the purpose of consumption (Statens livsmedelsverks författningssamling, 1983). In Finland, the National Board of Health recommended a decrease in consumption of reservoir fish with mercury concentrations greater than 0.5 ppm. The Board forbade the sale of fish with mercury levels greater than 1.0 ppm (Verta *et al.*, 1986a). In Canada, the mercury consumption guideline for fish or fish products has been set at 0.5 ppm. Products containing higher than 0.5 ppm mercury cannot be sold within Canada but may be sold on the world market to countries with higher mercury tolerances. In the United States, based on findings from acidified lakes in Wisconsin, a health advisory was issued by both the Wisconsin Department of Natural Resources and the Wisconsin Division of Health (1988) for people consuming sport fish from certain areas linked to high mercury levels.

Globally, fish with mercury concentrations less than 0.5 ppm have been accepted as representative of natural mercury levels for unpolluted water systems (Holden, 1972). Conversely, fish having mercury levels greater than 0.5 ppm indicate evidence of industrial pollution or allogenic loading. Like Canada, Finland had a problem with industrial pollution and fish with elevated levels of mercury (Häsänen and Sjöblom, 1968). A ban on the use of mercury compounds has led to reduced mercury levels in fish from many locations (Nuorteva *et al.*, 1979; Lodenius, 1991). However, many investigators have found elevated mercury levels in fish from

pristine lakes and other remote areas unaffected by industrial sources of mercury, due to autogenic loading (Korityohann *et al.*, 1974; Wobeser *et al.*, 1970; Johnels *et al.*, 1967; Bodaly *et al.*, 1984a; Holden, 1972; Kleinert and Degurse, 1972; Surma-Aho *et al.*, 1986a; 1986b; Lodenius *et al.*, 1983; Mannio *et al.*, 1986; Rask and Metsälä, 1991).

2.3 Remediation

Of great public concern is how quickly and effectively a polluted or contaminated site can be cleaned and restored to its former uses. Because the removal of all forms of mercury from an aquatic system is virtually impossible, Bisogni and Lawrence (1975) suggest reducing or eliminating methylmercury formation. They present three possible remedial procedures to reduce the amount of mercury available for methylation: (1) change the mercury binding characteristics of the sediments; (2) eliminate or reduce the amount of organic or nutrient input to the benthic region; and (3) reduce the total inorganic mercury concentration. Fitzgerald *et al.* (1991) suggest that the in-lake production of metallic mercury (Hg^0) would reduce the amount of mercuric (Hg^{2+}) substrate available to the microbial community for mercury methylation. Ramamoorthy and Blumhagen (1984) concluded that increased levels of organic matter decreased the uptake of mercury by fish. Verta

(1984) hypothesized that decreased fish mercury levels could be attained by removing methylmercury from the fish biomass, thereby reducing the amount of mercury available for cycling. In an extensively fished lake, Verta (1990) found decreased mercury levels in fish as a result of faster growth rates and reduced dietary intake of methylmercury. Verta (1990) indicates that for small lakes, overfishing may be a reasonable way to reduce the mercury levels in top predators to an allowed marketing level as a younger age structure would likely be created. Billen *et al.* (1974) suggest that methylmercury-degrading bacteria can exist in locations with high methylmercury concentrations thereby reducing the amount of methylmercury in a particular environment. Biodegradation could take place through the use of the pollutant (for energy and carbon requirements) or through enzymatic modification to the pollutant without a nutritional benefit from the toxin (Billen *et al.*, 1974). For acidified lake systems, Winfrey and Rudd (1990) suggest that fish mercury levels could be decreased through a reduction in a lake's acidity. Rudd *et al.* (1980b) and Turner and Rudd (1983) suggested that low-level additions of selenium to the water column may also reduce fish mercury body burdens. This suggestion was tested and was found to reduce fish mercury levels for a Swedish system (Björnberg *et al.*, 1988) and a polluted Canadian system, the English-Wabigoon River System in northwestern Ontario (Rudd and Turner, 1983a; 1983b; Turner and Rudd, 1983). In addition, Turner and Swick (1983) indicated selenium additions to the water column were not as effective at reducing a fish's mercury burden as selenium additions to food

organisms. Jernelöv and Lann (1973) discuss the feasibility of restoring mercury contaminated ecosystems and the methods employed, such as the removal of mercury deposits through dredging. They indicate that there are both technical and economic problems which must be overcome before the processes can be practically applied. In addition, they provide evidence that the disturbance caused by dredging would serve to resuspend particulate matter and could actually increase mercury methylation.

2.4 Biogeochemistry

The processes by which mercury compounds are assimilated, stored and eliminated from biota constitute a small fraction of the total mercury cycle. Winfrey and Rudd (1990) present a figure of the biogeochemical cycling of mercury species within a freshwater lake (Figure 1). Biota add complexity to the mercury cycle due to the dynamics of, and interactions between, various food web components. As shown in Figure 1, the organic methylmercury ion (CH_3Hg^+) is the primary mercury compound bioaccumulated in fish. Methylmercury has recently been detected in rain (Bloom and Watras, 1989) and water from catchment areas (Lee and Hultberg, 1990) but it is rarely deposited in large quantities directly into lakes (Winfrey and Rudd, 1990). It is probable that the methylmercury is formed either in the catchment area or in the lake from the methylation of inorganic mercury (Hg^{2+}).

The bioavailability of mercury species is also of concern. Suspended sediments are believed to be important in the bioavailability (Ramamoorthy and Blumhagen, 1984) and the bioconcentration of toxic substances (Gibbs, 1973; Hem, 1976; Karickhoff and Brown, 1978; Popp and Laquer, 1980; Tessier *et al.*, 1980). Studies have shown that the mercuric ion (Hg^{2+}) is readily absorbed by organic and inorganic particulates (Beneš and Havlik, 1979; Rudd and Turner, 1983; Rogers *et al.*, 1984; Cranston and Buckley, 1972; Hannan and Thompson, 1977) and by dissolved organic carbon, DOC (Miller, 1975). These processes may limit the amount of mercury available for methylation (Rudd and Turner, 1983; Miskimmin, 1989). In the presence of hydrogen sulfide (H_2S) the mercuric ion (Hg^{2+}) precipitates as mercuric sulfide, HgS (Winfrey and Rudd, 1990). Jernelöv (1968) suggested that mercuric sulfide would only become mobilized after oxidation to mercuric sulfate (HgSO_4). Furutani and Rudd (1980) showed that mercury could be methylated in the water column and in the presence of mercuric sulfide. Therefore, the mercury was not being completely sequestered into the sediments as mercuric sulfide (Furutani and Rudd, 1980). Gillespie and Scott (1971) showed that under aerobic conditions, mercuric sulfide in the sediments could be mobilized and absorbed by fish.

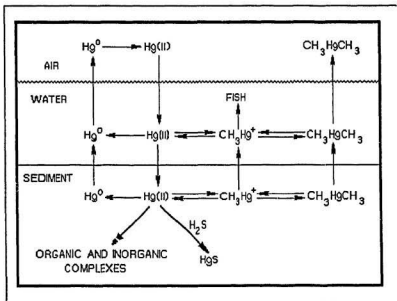

Figure 1 Mercury cycle (after Winfrey and Rudd, 1990).

2.5 Methylation

Methylation of mercury is a small part of the total mercury cycle but has a critical influence on fish mercury concentrations. Methylmercury is produced in both the sediment and the water column (Westöo, 1966; Jensen and Jernelöv, 1969; Jernelöv, 1970) and in soils (Van Faassen, 1976; Yamada and Tonomura, 1972). Methylation may occur abiotically (Rogers, 1977; Nagase *et al.*, 1982; 1984; Lee *et*

al., 1985) or biotically through bacterial mediation (Jensen and Jernelöv, 1969). The mercuric ion (Hg^{2+}) may be formed through photocatalytic reactions (Lindqvist and Rodhe, 1985; Brosset, 1987; Iverfeldt and Lindqvist, 1986) of elemental mercury (Hg^0), which is the predominant atmospheric mercury compound (Lindqvist and Rodhe, 1985; Slemr *et al.*, 1985). Ramamoorthy and Blumhagen (1984) also detected photochemical methylation of mercury.

A variety of organisms methylate mercury (Robinson and Tuovinen, 1984; Gilmour and Henry, 1991). Wood *et al.* (1968) first showed that methanogenic bacteria could produce methylmercury. Landner (1971) showed that *Neurospora sp.* was capable of methylation while Yamada and Tonomura (1972) demonstrated that *Clostridium cochlearium* could do the same. A number of aerobic gram-negative rods and gram-positive cocci that Hamdy and Noyes (1975) isolated from river sediments also proved able to methylate mercury. As well, sulfate-reducing bacteria can methylate mercury; their metabolism may be enhanced by sulfate-deposition (Gilmour and Henry, 1991). Methylation of inorganic mercury and mercury compounds occurs rapidly via microbial action in aquatic environments (Bisogni and Lawrence, 1975; Ramlal *et al.*, 1987; Williams and Coffee, 1975; Sommers and Floyd, 1974). Most of the mercury entering an aquatic ecosystem is inorganic and is strongly adsorbed onto organic and inorganic particulates in the water (Beneš and Havlik, 1979; Rudd *et al.*, 1980b) or reversibly bound to humic acid (Strohal and Huljev, 1971; Miller, 1975; Beneš *et al.*, 1976; Jackson *et al.*, 1980). Organic particulates, notably

phytodetritus, undergo decomposition that frees previously bound inorganic mercury for methylation (Ramlal *et al.*, 1987). Methylmercury is produced by microorganisms that metabolize the mercuric (Hg^{2+}) ion to detoxify their environment (Pan-Hou and Imura, 1982) or as a result of errors in the synthesis of organic molecules such as amino acids (Wood *et al.*, 1972). Some bacteria can eliminate methylmercury by converting it to methane (CH_4) and elemental mercury, Hg^0 (Tonomura and Kanzaki, 1969; Tonomura *et al.*, 1972). Mercury must be present in its mercuric ion form to undergo biological methylation (DeSimone *et al.*, 1973).

Methylation rates are influenced by organic content (Olson and Cooper, 1976; Rudd *et al.*, 1983); pH (Ramlal *et al.*, 1985; Xun *et al.*, 1987); the concentration of inorganic mercury (Yamada and Tonomura, 1972); the bacterial species present (Vonk and Kaars Sijpesteijn, 1973); the growth rate of methylating microbes (Bisogni and Lawrence, 1975); and the oxygen concentration in the water (Bisogni and Lawrence, 1975). Consequently, methylation rates are site specific and difficult to generalize.

2.6 Bioaccumulation and Biomagnification

The literature on uptake and accumulation of essential and nonessential metals in fish is both confusing and conflicting (McFarlane and Franzin, 1980). To varying

degrees, living creatures possess the ability to accumulate, within their tissues, substances that are only slightly biodegradable (Boudou *et al.*, 1979).

Bioaccumulation occurs naturally when the assimilation rate of a specific compound is greater than the excretion rate. This contrasts with biomagnification, the process by which a slightly biodegradable compound is magnified through the food chain.

Mercury, when dissolved in the water column, is at its lowest concentration. Each successive level of the food chain displays a higher concentration than the previous level. Biomagnification continues to the top of the food chain where top predators display the highest concentrations. The accumulation of mercury in fish due to biomagnification was generally associated with industrial discharges of mercury to natural waters (D'Itri, 1972; Kleinert and Degurse, 1972; Rai *et al.*, 1992). More recently, increased fish mercury concentrations have been found in natural lakes without industrial or point sources of pollution (Wren and MacCrimmon, 1983; Sloan and Schofield, 1983; McMurtry *et al.*, 1989; Grieb *et al.*, 1990; Wiener *et al.*, 1990; Bodaly *et al.*, 1993). Globally, human activities have raised the mercury concentration in the environment well above natural levels (Johnels *et al.*, 1967) and these increased mercury levels might be detected in aquatic biota.

Biomagnification occurs predominately with lipid soluble compounds such as DDT (1,1-bis(4-chlorophenyl)-2,2,2-trichloroethane) and methylmercury. Fish show increased mercury levels in their tissues due to this process (Stock and Cucuel, 1934; Raeder and Snekvik, 1941; Rankama and Saham, 1950). The retention time of

lipophilic substances in fish flesh can be years. This partly accounts for the effect of size and age on tissue concentrations (Leland *et al.*, 1976; Hasselrot, 1974). In general, large fish have greater white muscle mercury concentrations both within species and within populations (Scott, 1974). However, the relationship between mercury concentration and length is not consistent within species (Scott and Armstrong, 1972; Scott, 1974). It is well documented that fish mercury levels increase with fish size (Scott and Armstrong, 1972; Scott, 1974; Huckabee *et al.*, 1979). However, the increases in mercury body burdens of fish from newly impounded reservoirs in northern Manitoba were not a result of changes in the average size of fish sampled (Bodaly *et al.*, 1984a). In addition, Bodaly *et al.* (1984a) found that during the same time period and at the same location, there were no increases in fish mercury concentrations from undisturbed lakes. Phillips (1976) showed that the mercury concentrations present in fish representing the same year class from a contaminated reservoir were independent of size.

Methylmercury (CH_3Hg^+) is the most hazardous mercury species. It is more toxic and more easily bioaccumulated than inorganic forms because it can easily penetrate membrane barriers, facilitating the absorption of the contaminant in organisms and its transport and fixation in different tissues (Boudou *et al.*, 1979). This mercury compound is readily bound to thiol or sulfhydryl groups, SH^- (Takahashi and Hirayama, 1971), which are associated with neurons. Consequently, methylmercury is a neurotoxin and, if exposure is high, can cause Minamata disease

(methylmercury poisoning). Methylmercury also demonstrates a high capacity for intracellular storage, thus increasing the biological half-life of the toxicant in the organism (Boudou *et al.*, 1979). Westöb (1966) first demonstrated that most of the mercury found in fish is in the methylated form. Recently, this finding has been confirmed by Bloom (1992) and Lasorsa and Allen-Gil (1995). Olson *et al.* (1973) suggested that the rate of methylmercury accumulation is greater than the rate of inorganic mercury accumulation as demonstrated by the anomalous tissue distribution of these two mercurials, suggesting inorganic mercury does not require methylation prior to entry into the fish. Gavis and Ferguson (1972) concluded that aquatic organisms can extract methylmercury compounds from the water in preference to inorganic mercury. However, more recent experiments have indicated the overwhelming importance of food as the primary mercury uptake pathway for fish (e.g. Hall *et al.*, 1994). Potter *et al.* (1975) suggested that the patterns of mercury uptake, accumulation, and elimination in fish were species specific. The biological half-life of methylmercury may also be species specific (Friberg and Vostal, 1972). Reported values range from about five months for bluegills, *Lepomis macrochirus* (Burrows and Krenkel, 1973), to over 200 days for rainbow trout, *Oncorhynchus mykiss* (Giblin and Massaro, 1972), to nearly 700 days in northern pike, *Esox lucius* (Lockhart *et al.*, 1972), and to more than 1,000 days in flounder, (Järrenpää *et al.*, 1970). The reported differences could be partly size related.

Methylmercury enters fish through two different pathways: either direct

adsorption from the water column across the gill membrane or absorption of methylmercury from ingested food items. Predicting the relative importance of methylmercury from food or water is complicated by geographical and seasonal variations in methylmercury availability and by seasonal changes in prey availability and predator feeding habits (Phillips and Buhler, 1978). Mercury uptake via the gills is directly related to metabolic rate, which is determined primarily by fish size and secondarily by water temperature and the concentration of dissolved oxygen (Phillips and Buhler, 1978). Ribeyere *et al.* (1991) found that both pH and temperature affect mercury bioaccumulation. Norsrom *et al.* (1976) reported a 12% efficiency for respiratory assimilation of methylmercury while Fagerström and Åsell (1973) reported a 14% efficiency for assimilation of dietary methylmercury. The net efficiency of methylmercury assimilation ranges from 67% – 94% (Hannerz, 1968; deFreitas *et al.*, 1974; Suzuki and Hatanaka, 1975; Matida *et al.*, 1971; deFreitas *et al.*, 1977).

There has been some debate over the primary pathway for mercury accumulation by fish. Exposing pond animal communities to methylmercury, Hannerz (1968) found that the tissue concentrations in the organisms were not related to trophic level, suggesting that direct adsorption from the water column was the major route for methylmercury accumulation. Armstrong and Hamilton (1973) found that, in a mercury contaminated system, mercury concentration was related to food selection. Their study indicated that omnivorous organisms, detritus feeders, and bottom dwelling invertebrates had considerably higher mercury levels than either

herbivorous organisms or zooplanktivores. Phillips *et al.* (1980) found the rate of mercury accumulation was faster in piscivorous species (i.e. northern pike, walleye *Stizostedion vitreum*, and sauger *Stizostedion canadense*) than in planktivores (i.e. black crappie *Pomoxis nigromaculatus*, and white crappie *Pomoxis annularis*). Wren and MacCrimmon (1986) found significantly higher mercury levels in predatory species than in other species of comparable age. Small yellow perch *Perca flavescens* are common prey items for walleyes (Colby *et al.*, 1979) and other piscivorous species and presumably play a primary role in the trophic transfer of mercury up the food chain (Cope *et al.*, 1990). Jernelöv and Lann (1971) attributed 60% of the mercury present in northern pike from 3 Swedish rivers to mercury in the fish's food. The percentage of organic-to-total mercury has been found to increase with position in the food chain (Gardner *et al.*, 1975; Hildenbrand *et al.*, 1975; Leland *et al.*, 1976; Meister *et al.*, 1979) with top predators having the greatest concentrations of toxic methylmercury. deFreitas *et al.* (1977) suggest that an organism's lifespan and growth rate are important determinants of pollutant concentrations in tissues. Recently, field experiments relating mercury concentrations in the water to mercury concentrations in fish (Hall *et al.*, 1994) demonstrated that in lakes the primary methylmercury accumulation pathway was the food. This implies that the quantity of mercury accumulated directly from the water column is negligible when compared to the quantity accumulated via the food chain.

Regardless of the uptake path, mercury has toxic effects on wildlife. Stry and

Wiener (1991) present a critical review of bioavailability and toxicity of mercury compounds to fish. Mercury poisoning in its final (irreversible) stage is detectable from sensory-motor dysfunctions as mercury accumulates within the central nervous system (Carley *et al.*, 1971; Putman, 1972). Hartman (1978) found that, when trout were given food with moderate to high doses of mercury, deficiencies in conditioned avoidance performance resulted. However, Rucker and Amend (1969) and Amend (1970) found no prolonged effects of organic mercury poisoning in fish as fish growth rates diluted the initial mercury burden. Burrows and Krenkel (1973) suggest that demethylation could be occurring in the liver and kidneys. Trout have been observed to have increased mucus production in the presence of sublethal concentrations of mercuric chloride (Lock and Van Overbeeke, 1981). Varnasi *et al.* (1975) suggest that the structural properties of the mucus covering the gill epithelium changes, resulting in increased permeability to methylmercury.

2.7 Autogenic Mercury Loading

In addition to industrial sources of mercury, there are a number of environmental stresses that result in increased mercury concentrations in biota. Recently, there have been mercury problems associated with "pristine" environments. Many of these areas are remote and isolated from point sources of mercury pollution

such as mining, chlor-alkali plants, or pulp and paper mills. Research has shown that the cause of increased mercury levels in fish and wildlife may be acid stress, atmospheric deposition, reservoir impoundment, or some combination of these.

Acidification was thought to aggravate the already harmful ecological impacts of mercury contamination through the production of methylmercury (Jernelöv and Lann, 1973; Brouzes *et al.*, 1977). Elevated fish mercury levels have been observed in poorly buffered, low pH lakes in areas remote from point sources of emissions for lakes on the Canadian Shield (Wren and MacCrimmon, 1983); in the Adirondaks (Sloan and Schofield, 1983); in Maine (Akielazek and Haines, 1981), Michigan (Grieb *et al.*, 1990), and Wisconsin (Wiener *et al.*, 1990; Wiener, 1983); in Sweden (Björklund *et al.*, 1984; Lindqvist *et al.*, 1984) and Finland (Verta *et al.*, 1986); and in Ontario (Scheider *et al.*, 1979; Suns *et al.*, 1980). However, several researchers found that, in acidified waters, mercury was methylated more slowly than water at neutral pH levels (Baker *et al.*, 1983; Furutani *et al.*, 1984; Ramlal *et al.* 1985).

Mercury concentrations in water have been closely associated with color, possibly due to the concentration of humic and fulvic matter and the corresponding complexations between mercury and humic material (Mierle and Ingram, 1991). Jackson *et al.* (1980) found that mercury was rapidly removed from the water column at pH 6.7 – 6.8 due to its strong electronegativity but was removed more slowly at pH 5.1 due to its large ionic radius. Jackson *et al.* (1980) found that mercury formed exceptionally strong covalent bonds with humic matter. Rask and Metsälä (1991)

found a trend towards higher mercury levels in northern pike from areas which were either acidic or humic as compared to uncolored and nearly neutral lakes. Driscoll *et al.* (1994) found a strong, positive relationship between fish mercury concentrations and dissolved organic carbon (DOC) to a maximum of about 8 mg C/L, after which fish mercury concentrations began to decline. Other researchers have reported elevated mercury body burdens for fish inhabiting natural, unpolluted lakes with humic, brown water (Hultberg and Hasselrot, 1981; Björklund, 1982; Paasivirta *et al.*, 1983; Verta *et al.*, 1986b; Driscoll *et al.*, 1995).

Increased fish mercury concentrations have also been observed for newly impounded reservoirs across Canada and around the world. Once a reservoir is impounded, mercury levels in fish begin to rise beyond the Canadian consumption guideline of 0.5 ppm mercury. The effects of reservoir impoundment on fish mercury concentrations are reviewed in the next section, before quantitative models are developed.

3.0 EFFECTS OF RESERVOIR IMPOUNDMENT

Following reservoir impoundment, species shifts and rearrangements are common as a fluvial system is converted into a lotic one (Lindström, 1973). Reservoir formation severely alters the existing chemical and physical characteristics of an aquatic ecosystem. Impoundment of Southern Indian Lake and the diversion of the Churchill River in northern Manitoba affected the optical, thermal, and biological regimes (Hecky, 1984). After impoundment, lake temperatures, light available for photosynthesis (PAR) and Secchi disk transparencies all decreased (Hecky, 1984). Primary production in a new reservoir will change in a variety of ways depending on the specific location (Rodhe, 1964; Funk and Gaufin, 1971; Chamberlain, 1972; Soltero and Wright, 1975; Duthie and Ostrofsky, 1975; Pyrina, 1979; Hecky and Guildford, 1984). Hecky and Guildford (1984) found that phytoplankton increased the efficiency of light utilization during photosynthesis when mean light intensity was lowered as a result of impoundment. Given decreased temperatures and Secchi disk transparencies (Hecky, 1984), Patalas and Salki (1984) concluded that compositional changes in the zooplankton community were a result of decreased primary production. However, in regions of Southern Indian Lake where no changes in phytoplankton production had occurred (Hecky and Guildford, 1984), standing crops of zooplankton decreased (Patalas and Salki, 1984) while zoobenthos increased (Wiens and Rosenberg, 1984).

The drastic change in the distribution of fish populations after flooding could affect exposure to mercury. After Southern Indian Lake was flooded, there was an observed dispersion of lake whitefish out of the lake and into the diversion channel. This may have resulted from the decrease in light penetration as a result of shoreline erosion and increased levels of suspended sediment (Bodaly *et al.*, 1984b; Newbury and McCullough, 1984). The light intensities on the bottom during the day (Hecky, 1984) were below those required for effective schooling and feeding for most species (Blaxter, 1970).

Increased fish productivity has been observed in new reservoirs at all trophic levels (Ellis, 1936; Stroud, 1967; Nilsson, 1973; Bodaly and Lesack, 1984). One species for which impoundment effects have been studied is the northern pike (Hassler, 1970; June, 1970; 1971; Cooper, 1971). Bodaly and Lesack (1984) found that Wupaw Bay (Southern Indian Lake) produced a very strong year class of northern pike during the first year of impoundment. This trend has been observed in other reservoir systems where terrestrial vegetation becomes covered by water, providing increased spawning habitat (Gasaway, 1970; Beckman and Elrod, 1971; Sumari and Westman, 1969; Holcik, 1968; Domanevskii, 1957; Hassler, 1969; 1970).

The problem of increased mercury concentrations in reservoir fish populations has been known for some time (Smith *et al.*, 1974; Abernathy and Cumbie, 1977; Lodenius *et al.*, 1983; Bodaly *et al.*, 1984a; Boucher *et al.*, 1985). Typically, fish mercury levels rise rapidly in a few years following impoundment. They then

gradually decline, remaining above the normal background levels observed for natural environments for many years (Johnston *et al.*, 1991). The observed rate of decline in fish mercury concentrations is variable. Initial investigators suggested a return to baseline mercury concentrations within five years (Abernathy and Cumbie, 1977; Cox *et al.*, 1979). More recently Bodaly *et al.* (1984a) predicted a slower decline with fish mercury levels remaining elevated for decades. Even after mercury found in lake sediments has been depleted, biomagnification in higher organisms is expected to continue for some time (Hildenbrand *et al.*, 1975; Pfister, 1978). Verta (1984) proposed that elevated fish mercury body burdens can occur even if the mercury loading is low due to an efficient recycling of methylmercury through lacustrine food webs. Ramsey (1990) estimated that fish mercury levels would remain elevated by a factor of 2 – 3 for at least 50 years and mercury concentrations could remain elevated above the baseline level for as long as 150 years. Cox *et al.* (1979) note that if impoundments are used for fisheries, there needs to be close monitoring of mercury levels in predatory fish.

After impoundment the source of mercury to fish is not apparent because excessive mercury levels are not typically present in the water (Meister *et al.*, 1979). The primary source of mercury to new impoundments is not anthropogenic. Meister *et al.* (1979) identified inundated soil as the source but other sources are possible (Cox *et al.*, 1979). Smith *et al.* (1974) suggested that the mercury source to a Utah reservoir was either insoluble mercury salts or sulfides found in the mud. Meister *et*

al. (1979) hypothesized that mercury was being assimilated through food sources rather than directly from the water column. These authors eliminated point source pollutants as the mercury source because fish showed no unusual levels of other heavy metals or pesticides.

The flooding of terrestrial soil and vegetation during impoundment adds both inorganic mercury and organic nutrients to the aquatic system. The bottom of the reservoir is disturbed by washouts and flooding, resulting in a release of organic matter and nutrients from decomposition (Grimås, 1965). Also, nutrients are released from cleared land around new reservoirs (Romell, 1967). These additions can accelerate microbial methylation (Rudd *et al.*, 1980a; Wright and Hamilton, 1982; Bodaly *et al.*, 1984a). Substantial methylation occurred in the three years following impoundment of La Grande 2 Reservoir in northern Quebec (Verdon *et al.*, 1991). The decomposition of organic matter (i.e. inorganic carbon, total phosphorous) peaked after three or four years (Schetagne, 1990).

Hecky *et al.* (1991) suggested that the organic matter from flooded soil and vegetation has a greater impact on fish mercury levels than either inorganic mercury or nutrients. Measures of organic content have been linked to fish mercury concentrations in both natural lakes (McMurtry *et al.*, 1989) and reservoirs (Mannio *et al.*, 1986; Verta *et al.*, 1986a). When primary production is stimulated, there are two opposing mechanisms affecting the concentration of mercury in fish. In the first process, the increased supply of decomposable algal carbon stimulates the methylating

bacteria, eventually increasing fish mercury body burdens at upper trophic levels (Furutani and Rudd, 1980; Rudd *et al.*, 1983; Rudd and Turner, 1983b). In the second process, the stimulation of primary production tends to reduce the concentration of methylmercury in fish if the bioaccumulation of mercury is diluted by faster fish growth rates (Rudd and Turner, 1983b; deFreitas *et al.*, 1974; Beijer and Jernelöv, 1979). Thus, the tissue concentration of mercury in faster growing species (i.e. prey) would be lower relative to the slower growing species (i.e. predators). However, in field experiments, Rudd *et al.* (1983) found that increasing fish growth rates through stimulation of primary production resulted in substantial increases in fish mercury body burdens. Under natural conditions, Abernathy and Cumbie (1977) found that mercury levels in largemouth bass (*Micropterus salmoides*) from three reservoirs in the same drainage basin of the Southeastern United States were highest in younger, relatively oligotrophic reservoirs and were significantly lower in older, more eutrophic reservoirs.

Bioaccumulation of mercury compounds occurs at every level in aquatic food chains (Nriagu, 1979). Algae accumulate and concentrate mercury from the water primarily by surface absorption and also by adsorption (Hannerz, 1968; Glooschenko, 1969). For algae, the uptake of both organic and inorganic mercury is proportional to the length of exposure and the concentration (Fang, 1973; Mortimer and Kudo, 1975). Since forage fish contain much higher concentrations of methylmercury than zooplankton (Jernelöv and Lann, 1971; Cox *et al.*, 1975), it has been suggested that

large, piscivorous species may ingest most of their mercury body burden through the food chain while lower trophic feeders may absorb most of their mercury via the skin or gills (Bruce, 1984; Phillips and Buhler, 1978; Armstrong and Scott, 1979; Boëtius, 1960; Hannerz, 1968; Hasselrot, 1968; Amend *et al.*, 1969; Backstrom, 1969; Rucker and Amend, 1969; Olson *et al.*, 1973; Olson and Fromm, 1973; Uthe *et al.*, 1973; deFrietas *et al.*, 1974; Hasselrot and Göthberg, 1974). Some higher species may possess the ability to convert inorganic mercury into methylmercury (Westö, 1968; Imura *et al.*, 1972). Pennachioni *et al.* (1976) could find no evidence of methylation in fish. Rudd *et al.* (1980a) suggested methylmercury was being produced by methylating microbes in the intestines of fish. The conflicting reports and disagreement concerning mercury bioaccumulation in fish arises both from a lack of information concerning the specific mercury exposure regimes experienced by fish and from a lack of quantitative data relating food uptake to water uptake (Phillips and Buhler, 1978).

Adsorption of mercury from the water column is another pathway for mercury accumulation in fish. Wobeser *et al.* (1970) suggested the epithelia was an important route for direct mercury accumulation. In their opinion, this may partially explain the lack of specific variation in fish mercury concentrations, even among species with different feeding habits. Some authors have suggested that mercury is taken up through a fish's mucus layer and/or through the skin (McKane *et al.*, 1971; Burrows *et al.*, 1974). Strange *et al.* (1991) suggested that passive accumulation of mercury is

highest in littoral zone species (e.g. northern pike), which spend a majority of their time nearshore where methylation rates are highest.

The food chain is a critical source of mercury to fish (Huckabee *et al.*, 1978; Huckabee *et al.*, 1975; Lock, 1975). Huckabee *et al.* (1978) found that about 50% of the muscle mercury content was derived from the food. Surma-Aho *et al.* (1986a, 1986b) suggested that large amounts of methylmercury or mercury that was ready to be methylated are dissolved into the water phase and accumulated, particularly by the zooplankton community, following impoundment. Boudou *et al.* (1979) demonstrated that, for a simple food chain consisting of a green algae (*Chlorella vulgaris*), a zooplankter (*Daphnia magna*) and first level carnivorous fish (*Gambusia affinis*), the quantities of the substance bioaccumulated by the consumer fish corresponded to the amount of mercury ingested. Potter *et al.* (1975) and Lodenius *et al.* (1983) found that species in the highest trophic levels had the highest tissue mercury concentrations. For Labrador fishes, Bruce and Spencer (1979) observed the highest (> 0.5 ppm) mean mercury values in the two piscivorous species studied (lake trout *Salvelinus namaycush* and northern pike) while lower mercury levels (< 0.5 ppm) were observed in the non-piscivorous species (whitefish *Coregonus clupeaformis*, white sucker *Catostomus commersoni*, longnose sucker *Catostomus catostomus*, and brook trout *Salvelinus fontinalis*). Similarly, Smith *et al.* (1974) found a trophic level effect for mercury concentrations in fish from a Utah reservoir, with predators having the highest mercury body burdens. Surma-Aho *et al.* (1986a, 1986b) showed that, in

Finnish lakes and reservoirs, the concentration of mercury increased substantially up the food chain. Phillips *et al.* (1980) showed that mercury was accumulated more rapidly in piscivorous species (northern pike, sauger and walleye) than in planktivorous species (black and white crappies) apparently due to the amount of mercury consumed. Further evidence for food chain bioaccumulation of methylmercury comes from laboratory experiments (Kania *et al.*, 1974). Fish demonstrated decreased ability to avoid predators as sublethal concentrations of mercury increased. This result indicates that, under natural conditions, predatory fish could have high body burdens of mercury because mercury enriched prey are easier to catch and less energy is required to catch them.

The physical and chemical characteristics of an aquatic ecosystem may limit, enhance, or otherwise modify a fish's uptake of mercury from the water (Burkett, 1974). Lathrop *et al.* (1991) list several variables that influence fish mercury levels. Briefly these include: sediment mercury (Håkanson, 1980; Håkanson *et al.*, 1988; Cope *et al.*, 1990); chlorophyll-a, total phosphorous, and other lake bioproductivity indices (Håkanson, 1980; Helwig and Heiskary, 1985; Lanrop *et al.*, 1989); water aluminum (Helwig and Heiskary, 1985); dissolved organic carbon or color (McMurtry *et al.*, 1989; Cope *et al.*, 1990; Grieb *et al.*, 1990); sediment organic matter (Håkanson, 1980; Verta *et al.*, 1986a; Cope *et al.*, 1990); and lake morphometry (Wren and MacCrimmon, 1983; Helwig and Heiskary, 1985). Increased temperature has been shown to increase fish mercury levels because fish are less tolerant of

mercury at higher temperatures (Amend, 1969; Hasselrot, 1968; Boëtius, 1960; MacLeod and Pessah, 1973). The rate of methylmercury uptake in fish has been positively correlated with metabolic rate and oxygen consumption in natural environments (Rodgers and Beamish, 1981) perhaps because fish increase their exposure to methylmercury by respiring larger volumes of water (Ponce and Bloom, 1991). Generally, factors that influence metabolic rates are the same as those that control mercury kinetics: the amount of mercury to which the organism is exposed (concentration in ambient water, sediment and food); temperature; water quality (pH, total dissolved solids, dissolved oxygen, degree of eutrophication, complexing ligands, etc.); sex; breeding status; ingestion rate; species; and metabolic differences (Nriagu, 1979; Forrester *et al.*, 1972; Olsson, 1976; Bishop and Neary, 1977; MacLeod and Pessah, 1973). Weight and age also affect mercury accumulation by fish because large, older fish tend to have higher mercury concentrations than small, younger fish (Uthé and Bligh, 1971; Jernelöv and Lann, 1971; Branson *et al.*, 1975). Scott and Armstrong (1972) found a positive correlation between mercury concentration and fish length. Similarly, mercury concentration was found to increase with fish length for all species collected from the Tongue River Reservoir in Montana (Phillips *et al.*, 1980). A positive relationship was also demonstrated between time of exposure to waterborne methylmercury and tissue concentrations of mercury (deFreitas *et al.*, 1977). Wren and MacCrimmon (1986) suggested that exposure time to waterborne mercury is less important than diet type in determining tissue mercury levels from

organisms inhabiting undisturbed lake environments. Variation in fish mercury concentrations may be due to alterations in formation and decomposition of methylmercury in response to differences in water chemistry between lakes, differences in mercury loading, watershed to lake area ratios and retention of mercury by watersheds (Mierle and Ingram, 1991).

Like other chemical substances in aquatic ecosystems, the environmental concentration of methylmercury is regulated by the concurrent processes of production and degradation (Brosset, 1981; Lexmond *et al.*, 1976). Inorganic mercury and mercury containing compounds can be rapidly transformed by microbial action in aquatic environments (Ramlal *et al.*, 1987). Anaerobic conditions enhance microbial methyl transfer which occurs when the methyl groups (CH_3^+) are transferred from methylcobalamine ($\text{CH}_3\text{-Co-5,6-dimethylbenzimidazolylcobamide}$) to the mercuric ion (Hg^{2+}) to form methylmercury (CH_3Hg^+) using both enzymatic and nonenzymatic reactions (Wood *et al.*, 1968; Sorensen, 1991). Bacteria capable of synthesizing alkylcobalamines in the presence of increased levels of nutrients also enhance methylation (Sorensen, 1991). Meister *et al.* (1979) suggested that anaerobic conditions favour the uptake of mercury from the soil through methylation under conditions present in lake sediments. Other bacteria eliminate methylmercury from aquatic systems by converting it to methane (CH_4) and elemental mercury, Hg^0 (Tonomura and Kanzaki, 1969; Tonomura *et al.*, 1972).

In reservoirs, most methylation takes place in flooded zones (Ramsey, 1989)

where the methylation/demethylation ratios are higher than at deep water sites (Ramsey and Ramlal, 1987). In Southern Indian Lake in northern Manitoba, the highest methylation/demethylation ratios occurred along the flooded shoreline (Ramlal *et al.*, 1986). This provides one explanation for increased mercury body burdens of fish following impoundment since most fish species spend the majority of their time in the littoral zone where habitat and feeding conditions are favourable. This observation points to increased bacterial methylation under aerobic conditions due to the oxygen regime associated with the littoral zone of most reservoirs. In contrast, Rudd *et al.* (1983) and Parks *et al.* (1984) found that, for the highly polluted Wabigoon-English River system, methylation rates were orders of magnitude higher under anaerobic conditions than under aerobic conditions. It appears that the observed differences between anaerobic and aerobic conditions are likely a function of the microbial species present, the microbial community's growth rate and the availability of mercuric ion species for methylation, rather than due to direct effects of oxygen concentrations.

In general, reservoir creation leads to elevated mercury levels at all levels of the aquatic food chain, especially in fish. The ability to predict these levels prior to impoundment would be useful in future environmental impact assessments (Johnston *et al.*, 1991). Bodaly *et al.* (1984a) found that fish mercury levels responded quickly to impoundment, with substantial increases within the first two to three years. Mercury concentrations in fish in Manitoba reservoirs showed no significant decline

after five to eight years of impoundment (Bodaly *et al.*, 1984a). Assuming that the increase in methylmercury production is proportional to the amount of organic matter introduced to the system, a relationship between the extent of flooding (ie. organic matter inundated) and mercury levels in reservoir fish is expected (Bodaly *et al.*, 1984a; Johnston *et al.*, 1991). The largest mercury flux to fish is seen where the rise in lake level and the areal extent of flooding are the greatest (Jackson, 1967).

Modelling fish mercury levels as a function of extent of flooding in reservoirs has been attempted with mixed results. Jones *et al.* (1986) related fish mercury concentrations to several physical and chemical characteristics of Canadian reservoirs. They found that the extent of flooding was not a useful predictive variable by itself. Johnston *et al.* (1991) also modeled fish mercury concentrations as an extent of flooding using two linear models. Their study included within-lake effects (change in surface level, percent flooding and flooded area to volume ratio) and upstream effects (upstream percent flooding and upstream flooded area to volume ratio). Johnston *et al.* (1991) demonstrated that upstream effects had a greater explained variance than within-lake effects but indicated that differences between predicted and observed mean mercury body burdens for some test cases may have been caused by the equal weighting given to with-in lake and upstream effects. The models of Johnston *et al.* (1991) also indicated the presence of geographical differences as some predictions were closer to the observed-predicted line than others. Håkanson *et al.* (1988) found a weak inverse correlation between lake size and mercury concentration in northern

pike in Swedish lakes, while McMurtry *et al.* (1989) found a positive correlation between the same two variables for Ontario lakes. For natural lakes in northwestern Ontario, Bodaly *et al.* (1993) found a strong inverse relationship between fish mercury concentrations and lake size. Also, fish mercury concentrations have been correlated with watershed area (Verta *et al.*, 1986b; McMurtry *et al.*, 1989; Suns and Hitchin, 1990). The results of these correlative studies are conflicting, perhaps because of the difficulty of isolating mechanisms in such studies. Experimental studies designed to identify mechanisms of mercury methylation showed that the addition of organic matter increased the rate of microbial activity and subsequently, the rate of mercury methylation (Rudd *et al.*, 1983). As part of the Experimental Lakes Area Reservoir Project (ELARP), Heyes *et al.* (1994) showed that newly flooded peat is ideal for sustaining high methylation rates due to increased temperatures and carbon and nutrients from decaying vegetation. Based on experimental studies (e.g. Rudd *et al.*, 1983; Heyes *et al.*, 1994), and on demonstrated correlations with watershed area (e.g. Verta *et al.*, 1986b; McMurtry *et al.*, 1989; Suns and Hitchin, 1990), I investigated whether change in fish mercury concentrations can be predicted from change in reservoir size.

4.0 MODEL DEVELOPMENT

A variety of factors can influence the accumulation of mercury in freshwater biota (Huckabee *et al.*, 1979). Comprehensive models of the kinetics of mercury in natural aquatic environments have not been developed (Bisogni, 1979) as they have for limiting nutrients such as phosphorus (Grimard and Jones, 1981). One consequence of this is that quantitative assessments of change in fish mercury levels due to development or alteration of reservoirs cannot be made. Recently, Harris *et al.* (1994) have developed a mass-balance mercury model using bioenergetics equations to simulate mercury dynamics following reservoir impoundment. Bioenergetics equations are commonly used to describe mercury accumulation by fish (e.g. Norstrom *et al.* 1976; Korhonen *et al.*, 1995). Parameters for Harris's model are currently being refined in an ongoing project involving Tetra Tech Inc., Department of Fisheries and Oceans Freshwater Institute, and Hydro Quebec. The predecessor of the current model was developed as part of a Master's thesis in conjunction with Ontario Hydro (Harris, 1991).

Work to date on the biogeochemistry of mercury in natural waters has focused largely on experimental studies of single factors under laboratory conditions although more recent studies on the biogeochemistry of mercury have been field oriented. These studies can provide some insight into the kinetics of mercury in natural systems but cannot be used to evaluate change in mercury level in fish under natural

conditions for several reasons. First, quantitative models have been developed from some factors but not for others. Second, the relative contributions of concurrent processes remain unknown. A third reason is that considerable unexplained variation exists in those parameters that have been estimated. Given the current state of knowledge, it is not feasible to construct highly detailed models based on a large number of parameters describing important processes leading to mercury uptake by fish.

An alternative to highly detailed models is the development of aggregate models that summarize the relation of a variable of interest (i.e. mercury levels in fish) to one or more readily measured environmental variables of known importance (i.e. change in area). Parameters of highly aggregated models can be completely empirical (Ryder, 1965; Peters, 1986), a hybrid of empirical and rational parameters (Platt *et al.*, 1981), or completely rational (Lehman, 1986). The present study presents two hybrid models to describe increase in mercury levels in fish as a function of change in reservoir size. This variable (change in area) was chosen for several reasons. First, this variable is easily obtained prior to impoundment thereby allowing for a useful prediction of fish mercury levels. The area of the lakes to be flooded can be calculated and the area of the reservoir has already been estimated by the hydroelectric developer. The evidence from correlation studies (e.g. Johnston *et al.*, 1991; Bodaly *et al.*, 1993) indicates that the change in area is a key variable. In addition, previous studies indicated that the source of mercury to new impoundments

was the flooded soil (e.g. Meister *et al.*, 1979; Bodaly *et al.*, 1984a), which would vary with reservoir size. Finally, experimental studies have shown that the addition of organic matter increases the rate of microbial methylation (e.g. Rudd *et al.*, 1983; Heyes *et al.*, 1994).

Bodaly *et al.* (1984a) first reported that the increase in mercury body burdens of three fish species appeared to be related to the change in flooded terrestrial area. This informal (verbal) model was used to develop a formal model as follows. Change in body burden can be defined formally as a ratio:

$$R_M = M_R M_L^{-1} \quad (1)$$

where M_R is mercury body burden (ppm) of fish in the postimpoundment reservoir and M_L is mercury body burden (ppm) of fish in the preimpoundment lakes. Preimpoundment fish mercury levels are easily obtained and are a necessary requirement for environmental impact assessments. Assuming this ratio increases in proportion to increase in mercury load:

$$\partial R_M / \partial H = k_1 \quad (2)$$

and

$$R_M = k_1 H \quad (3)$$

where H is total mercury load of a reservoir (g km^{-3}), and k_1 is a coefficient measuring transformation of environmental mercury into tissue mercury. These equations assume that k_1 does not change due to reservoir creation. Environmental load (H) can be partitioned into two components, the dilution of the present load (due to an increase in volume), and the enrichment by the added load (due to an increase in flooded area). That is:

$$H = c_L V_L V_R^{-1} + c_s (A_R - A_L) V_R^{-1} \quad (4)$$

where c_L is the mercury concentration prior to flooding (g km^{-3}); V_L is the lake volume (km^3) prior to flooding; V_R is the reservoir volume (km^3) after flooding; c_s is the concentration of mercury released from the soil (g km^{-2}); A_L is the lake area (km^2) prior to flooding; and A_R is the reservoir area (km^2) after flooding.

For geometrically similar bodies of water:

$$V = b_V A^3 \quad (5)$$

where S is a dimensionless shape factor with values of approximately $3/2$ and b_V is a constant with dimensions of length^{3-2S} . For lakes and reservoirs on the Canadian

shield, the value of S falls closer to 4/3 than 3/2, based on regression estimates (Schneider and Haedrich, 1989):

$$V = 8.2674 \times 10^{-9} A^{1.321} \quad (6)$$

The estimated shape parameter ($S = 1.321$), differs significantly from 3/2:

$$t = (1.50 - 1.321)/0.05306 \quad (7)$$

where the denominator is the root mean squared residual from a regression of the logarithm of volume against the logarithm of area, using data from Ryder (1965). The probability of obtaining the observed t-ratio of 3.37 under the null hypothesis $S = 3/2$, is $p < 0.001$, $df = 22$, using the t-distribution.

Substituting equation (6) into (4), and then (4) into (3) gives:

$$R_M = k_1 c_L (A_I/A_R)^{1.321} + k_1 c_S (A_R - A_I) b_V^{-1} A_R^{-1.321} \quad (8)$$

This model, which is a hybrid between a purely empirical and a purely rational model, assumes that mercury concentration in fish changes in direct proportion to environmental load (H).

An alternative model is that change in mercury level in fish is proportional to

change in mercury loading:

$$H^{-1} \partial R_M / \partial H = k_2 \quad (9)$$

and hence

$$R_M = e^{k_2 H} \quad (10)$$

Taking natural logarithms and substituting (6) into (4), and then (4) into (10) gives:

$$\ln(R_M) = k_2 c_L (A_L/A_R)^{1.321} + k_2 c_S (A_R - A_L) b_V^{-1} A_R^{-1.321} \quad (11)$$

Equations (8) and (11) are formal expressions developed from the informal model of Bodaly *et al.* (1984a) that fish tissue mercury depends on the amount of area flooded.

4.1 Model Evaluation

The goodness of fit of the data to an equation was evaluated by least squares regression, weighted for sample size. Goodness of fit was measured as the variance explained by multiple regression of observed values of R_M against a set of explanatory

variables. For equation (8), R_M was regressed against a dilution factor (D) and an enrichment factor (E):

$$R_M = b_{D1}D + b_{E1}E \quad (12)$$

where $D = (A_L/A_R)^{1.321}$ and $E = (A_R - A_L) b_V^{-1} A_R^{-1.321}$. b_{D1} is an estimate of k_1c_1 (equation 8) and b_{E1} is an estimate of k_1c_8 (equation 8). For equation (11) the regression equation was:

$$\ln(R_M) = b_{D2}D + b_{E2}E \quad (13)$$

where b_{D2} is an estimate of k_2c_L (equation 11) and b_{E2} is an estimate of k_2c_8 (equation 11). Calculations were carried out with the SAS package (SAS, 1985).

5.0 METHODS AND MATERIALS

5.1 Location of Reservoirs Used in this Study

Three major regions were chosen for this study, due primarily to mercury monitoring efforts in these regions. The first region was northern Manitoba and contains the reservoir complex created during the Southern Indian Lake/Churchill River Diversion Project (Figure 2). The second region was northern Quebec and contains the La Grande Complex (Figure 2). The reservoirs in this region were also created for the purpose of hydroelectric generation on a very large scale. The third region was insular Newfoundland (Figure 2). These developments are not on the same scale as either the Southern Indian Lake/Churchill River Diversion Project or the La Grande Complex, but were also created for the purpose of hydroelectric generation.

It is important to note that many of the reservoirs used in this study were impounded before mercury monitoring became a priority. This is especially true for many of the reservoirs impounded as part of the Southern Indian Lake/Churchill River Diversion Project and many of the reservoirs impounded in insular Newfoundland. Therefore, in order to determine "baseline" mercury concentrations, selected lakes within the same region were used as control lakes. These lakes were isolated from the reservoir systems under study and were remote from point sources

of mercury input.



Figure 2 Location of the three main areas of study: (1) Southern Indian Lake/Churchill River Diversion Project; (2) La Grande Complex; (3) Cat Arm Reservoir.

5.1.1 Southern Indian Lake/Churchill River Diversion Project -- Northern Manitoba

The Southern Indian Lake/Churchill River Diversion Project, located in northern Manitoba, diverted the Churchill River south for the purpose of hydroelectric generation. Figure 3 is a map of this project (after Newbury *et al.*, 1984). This region has been described in detail by Newbury *et al.* (1984). Briefly the climate of this region can be classified as continental, consisting of long cold winters and short cool summers. In winter, severely cold waves of polar continental air move southeastward across the region. The summer pattern is characterized by frequent cool periods following eastward-moving cyclones. The annual mean temperature for this region of Manitoba is -5°C . The annual precipitation is about 430 mm, associated with frontal weather systems. One third occurs as snow during the mid-October to late May. Snow cover period lasts approximately 200 days, with an average accumulated depth of snow of about 60 cm. The period of ice cover on Southern Indian Lake lasts from early November to late May. The vegetation in the Southern Indian Lake region is typical of the wide band of boreal forest or taiga that crosses midlatitude Canada. The black spruce (*Picea mariana*) is the predominant tree species in most areas while tamarack (*Larix laricina*) occurs in most of the wetlands in this region. Jackpine (*Pinus banksiana*) is abundant in well drained areas of the northern third of the basin and deciduous species are interspersed in the conifer forests (especially with recent fires). The most common species are aspen (*Populus tremuloides*), balsam poplar (*Populus balsamifera*), paper birch (*Betula papyrifera*),

willow (*Salix spp.*) and alder (*Alnus spp.*). The aquatic fauna is diverse. Seine catches have indicated the presence of: spottail shiner (*Notropis hudsonius*); emerald shiners (*Notropis atherinoides*); and yellow perch (*Perca flavescens*); while northern pike (*Esox lucius*); walleye (*Stizostedion vitreum vitreum*); and lake whitefish (*Coregonus clupeaformis*) are the predominant commercial species.

The impoundments created as part of this massive river diversion had noticeable effects on limnological conditions. Temperatures, light available for photosynthesis, and Secchi disk transparencies have all declined since impoundment. In addition, alteration of energy flux and storage terms in the lake's energy budget (a primary effect) was caused by increased mean depth diluting heat income in all regions. The impoundment of Southern Indian Lake has resulted in higher efficiencies of primary production in all regions, as indicated by higher light-saturated rates of carbon uptake per unit chlorophyll and by higher initial slopes of the hyperbolic light response relation of the suspended sediment from eroding shorelines, while deeper areas had relatively unchanged light penetration. Comparison of the mean water column light intensities from those turbid regions with the values of I_k (light intensity at the onset of light saturation) for phytoplankton indicated that these turbid regions are now light deficient on average. Phosphorus deficiency prior to impoundment as indicated by alkaline phosphatase activity per unit ATP, has been eliminated as the mean water column light intensity declined below $5 \text{ mEinstein m}^{-2} \text{ min}^{-1}$. Table 1 (after Hecky *et al.*, 1984) shows differences observed before and

after impoundment for various regions of Southern Indian Lake. Inundation ratio is the proportion of flooded land to postimpoundment water area (Wiens and Rosenberg, 1984). Table 2 (after Bodaly *et al.*, 1984a) shows the changes in water level and surface areas of several lakes impounded as part of this project.

Table 1: Comparison of morphometric, hydrologic, limnological, and biological factors for four Southern Indian Lake regions before and after impoundment (Hecky *et al.*, 1984).

	REGION							
	1		4		5		6	
	Pre	Post	Pre	Post	Pre	Post	Pre	Post
Inundation ratio	0	0.09	0	0.16	0	0.31	0	0.08
Mean depth (m)	8.0	10.1	12.1	13.0	4.9	5.9	3.5	5.8
Flushing time (yr)	0.12	0.17	0.23	1.4	1.5	2.8	4.2	0.03
Temperature change (°C)	0	-0.8	0	-1.3	0	-1.4	0	-1.3
Suspended sediment (mg L ⁻¹)	3.2	8.1	1.2	6.3	1.7	4.1	3.0	11.0
I (mE m ⁻² min ⁻¹)	6.2	4.0	10.0	4.9	15.9	9.8	13.9	5.5
Secchi disk (m)	1.4	0.9	2.9	1.3	3.0	2.3	1.6	0.7
Erosive input (g m ⁻² yr ⁻¹)	≈0	1390	0	3312	0	770	≈0	1700
Primary production (mg m ⁻² d ⁻¹)	530	460	570	560	400	720	220	290
Chlorophyll (mg m ⁻³)	4.6	5.0	2.9	4.0	2.4	4.4	1.9	3.6
Zooplankton biomass (mg m ⁻³)	905	707	930	625	1855	957	1486	933
Zoobenthos density (# m ⁻²)	6200	5500	3800	8300	2800	6100	1000	1500



Figure 3 Location of reservoirs impounded as a result of the Southern Indian Lake/Churchill River Diversion Project (after Newbury *et al.*, 1984).

Table 2: Changes in water level and surface area of several lakes affected by the Churchill River Diversion Project (Bodaly *et al.*, 1984a)

Lake	Pre-impoundment Level (m)	Post-impoundment Level (m)	Pre-impoundment Area (km ²)	Post-impoundment Area (km ²)	Relative Change (%)
Southern Indian	255.0	258.0	1 977	2 391	+ 21
Notigi Reservoir ¹			153	584	+ 282
Issett	250.6	258.2	3.7		
Karsakuwigamak	248.1	258	18.8		
Pemichigamau	247.8	258	19.3		
Central Mynarski	251.1	258	11.5		
West Mynarski	249.0	258	6.2		
Rat	247.8	257.9	78.4		
Notigi	242.0	257.2	15.1		
Wapisu	239.9	243.2	49	67	+ 37
Threepoint and Footprint	239.0	242.6	75	103	+ 31
Wuskwatim	231.0	233.0	70	79	+ 13

1 - Preimpoundment water area for Notigi reservoir is the sum of the several lakes (listed under Notigi Reservoir) that existed before impoundment

5.1.2 La Grande Complex -- Northern Quebec

The La Grande complex located east of James Bay in northern Quebec is shown in Figure 4 (after Brouard *et al.*, 1989). The La Grande Complex has been described extensively by Brouard *et al.* (1989). Briefly, the watershed covers some 175 000 km². The climate in this area is typically cold continental due to its location in the humid subarctic zone. The annual mean temperature is -4°C. The prevailing winds blow from the west to the east and precipitation increases gradually from west to east, diminishing from south to north. The annual mean precipitation for this area is 765 mm. The hydrological regime is governed by rain and snow with heavy spring floods, decreased summer runoff and rain-induced fall flooding. Typically, there is very low runoff from November to early May followed by ice break-up and flooding until early June. The vegetation in the La Grande complex is dominated by open forests of black spruce, jack pine, larch and aspen. There are numerous peat bogs, especially on the coastal plain. The undergrowth is dominated by ericaceous shrubs, moss and lichens while riparian vegetation is dominated by willow shrubs. The terrestrial fauna of this region consists of 39 mammal species. In general, wildlife densities are lower than more southerly areas. The James Bay coast is characterized by high-potential waterfowl habitats. The aquatic fauna is also quite diverse and rich. There are 27 species of fish including: longnose sucker (*Catostomus catostomus*); white sucker (*Catostomus commersoni*); lake whitefish (*Coregonus clupeaformis*); cisco (*Coregonus artedii*); northern pike (*Esox lucius*); lake trout (*Salvelinus*

namaycush); walleye (*Stizostedion vitreum*); brook trout (*Salvelinus fontinalis*); landlocked salmon (*Salmo salar*); burbot (*Lota lota*); lake sturgeon (*Acipenser fulvescens*); yellow perch (*Perca flavescens*); and round whitefish (*Prosopium cylindraceum*). Typically, these fish exhibit slower growth than in southern Quebec but with longer lifespans, lower fecundity, later sexual maturity and spaced reproductive cycles. The water in the La Grande complex is highly transparent (secchi depth = 1.5 to 4.0 m); very well oxygenated (80% to 100% saturation); slightly acidic (5.9 to 6.9 pH units), slightly buffered (0.6 to 11.0 mg L⁻¹ bicarbonate), has a low mineral content (8 to 30 μ S cm⁻¹), is relatively rich in organic matter and poor in nutrients (0.004 to 0.01 mg L⁻¹ total phosphorous). Table 3 summarizes some of the characteristics of La Grande Complex reservoirs (after Brouard *et al.*, 1989). It is important to note that during the impoundment of La Grande 3 reservoir, there were some delays. There was an initial filling period of about 13 months then impoundment was halted for an additional 13 months due to technical difficulties. A second period of filling followed, lasting 12 months. However, 75% of the reservoir's surface had been flooded after the first year.

Table 3: Characteristics of La Grande Complex Reservoirs after Brouard *et al.* (1989)

Reservoir	Mean Drawdown (m) (Maximum Drawdown)	Maximum Area of Water (km ²)	Area of Flooded Land (km ²) (%)	Mean Depth (m)	Total Volume (10 ⁹ m ³)	Water Residence (months)	Mean Annual Flow (m ³ s ⁻¹)	Impoundment Period (year-month)
La Grande 2	3.3 (7.7)	2 835	2 630 (92%)	22.0	61.7	6.9	3 374	78-11 to 79-12
La Grande 3	5.5 (12.2)	2 420	2 175 (90%)	24.4	60.0	11.0	2 064	81-04 to 84-08
La Grande 4	8.0 (11.0)	765	700 (89%)	29.4	19.5	4.8	1 534	83-03 to 83-11
Opinaca	3.6 (4.0)	1 040	740 (71%)	8.2	8.4	3.8	845	80-04 to 80-09
Caniapiscou	2.1 (12.9)	4 275	3 430 (80%)	16.8	53.8	25.8	790	81-10 to 84-09

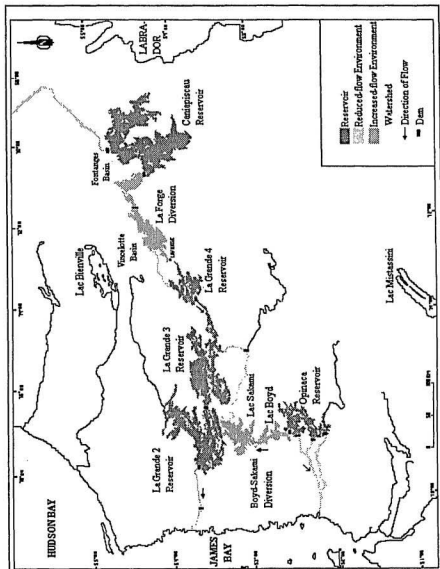

Figure 4 Location of reservoirs impounded in the La Grande Complex located in northern Quebec (after Brouard *et al.*, 1989).

5.1.3 Newfoundland

The Newfoundland region consists of three separate reservoir systems. One system contains Cat Arm Reservoir, the only reservoir impounded on the Great Northern Peninsula. The second system is also a single reservoir system that contains the Hinds Lake impoundment. The third Newfoundland system is the Bay d'Espoir area, which contains a series of several reservoirs. Long Pond Reservoir is located within this reservoir complex. Table 4 shows some of the physical characteristics of the reservoirs and control lakes found in insular Newfoundland.

CAT ARM RESERVOIR

Cat Arm Reservoir was constructed on a plateau in a mountainous area of the Long Range Mountains, on the Great Northern Peninsula of Newfoundland. Figure 5 is a map of Cat Arm Reservoir (after Newfoundland and Labrador Hydro, 1981). The Cat Arm Reservoir region has been described by Beak Consultants Ltd. (1980a; 1980b). Briefly, the climate of this area can be described as having short, cool summers and long, cold winters. Most of the precipitation in this region falls during the winter months as snow. The Cat Arm watershed has been glacially smoothed and scoured to the bedrock and only a thin overburden of glacial till remains. Prior to flooding, Cat Arm Lake showed no evidence of thermal stratification and oxygen levels were near saturation at all depths. Typical of many Newfoundland systems, the Cat Arm system supports relatively few species and a relatively small biomass with

the predominant phytoplankton being Chrysophyta. Nutrient levels are low and flushing rates are high thereby limiting the build up of phytoplankton communities. Resident fish populations consist of brook trout and Arctic char. Like many other areas of Newfoundland, the fish populations can be characterized as being abundant, slow-growing, short-lived and small in body size. The vegetation around Cat Arm Reservoir has an abundance of fir and spruce in the sheltered valleys of the mountain range. Scrub transition zones are typical between the wetlands and the wooded areas. The waterfowl of the area is limited. The area generally supports Canada geese, black ducks, and mergansers. It is believed that other bird species also inhabit this area. Moose and caribou are the primary big game mammals in this area. Other furbearing mammals are also believed to inhabit the area around Cat Arm Reservoir, notably the Newfoundland pine marten.

Table 4: Characteristics of Reservoirs and Control Lakes in Newfoundland

Reservoir	Surface Area (km ²)	Area of Flooded Land (km ²) (%)	Water Residence Time (days)	Mean Depth (m)	Impoundment Period (year-month)
BAY d'ESPOIR					
Great Burnt Lake	55	25 (45%)	3	10	82-11 to 83-05
Cold Spring Pond	17	7 (41%)	2	8	82-11 to 83-05
Long Pond	210	130 (62%)	45	16	66-12 to 67-05
Rocky Pond (Control)	7.9	N/A	unknown	unknown	N/A
HINDS LAKE					
Hinds Lake	46.54	21.41 (46%)	144	unknown	79-11 to 80-05
Eclipse Pond (Control)	3.9	N/A	unknown	unknown	N/A
CAT ARM					
Cat Arm	52.40	43 (78%)	199	18	84-05 to 85-06

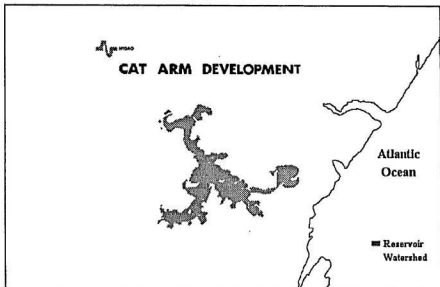

Figure 5 Map of Cat Arm Reservoir (after Newfoundland and Labrador Hydro, 1981).

5.1.4 Summary

Each of the three regions have their similarities and differences. Major similarities include climate and forest vegetation. Each of the three regions, northern Manitoba, northern Quebec and Newfoundland are typical north-temperate, boreal regions. The climate of these regions is continental, with long cold winters and short cool summers. The ice-cover period is typically November to May. The vegetation, coniferous forest, is also comparable between each of the three regions.

The most notable difference between the three regions is the aquatic fauna, which is more diverse in northern Manitoba and northern Quebec than in Newfoundland. Common commercial fishes of the former areas include northern pike, walleye, and lake whitefish. Other species of note are yellow perch, longnose sucker, white sucker, burbot and cisco. Cyprinids are common in these regions. In contrast, Newfoundland reservoirs only contain salmonids. Typically brook trout and ouananiche (landlocked Atlantic salmon) are the species present but Cat Arm Reservoir contains only Arctic char and brook trout. There are no cyprinids present and the only forage fish, found in some reservoirs, is the stickleback.

Differences also exist in geology. Reservoirs impounded as part of the Southern Indian Lake/Churchill River Diversion Project and the La Grande Complex were created on the Canadian Shield. The reservoirs impounded in Newfoundland lie on sedimentary rock of the Appalachians (western Newfoundland) or metamorphosed seafloor (central Newfoundland).

5.2 Mercury Data Used in the Analyses

It is important to note that mercury in fish is predominately in the methylmercury form (Westöð, 1966, 1973; Bache *et al.*, 1971; Kamps *et al.*, 1972; Bishop and Neary, 1976; Bloom, 1992) as it is for many other types of aquatic

organisms. Wobeser *et al.* (1970) found that the concentration of mercury in fish livers and kidneys was about two times that found in the muscle. However, fish muscle mercury concentrations are generally reported since the muscle is the part of the fish commonly consumed by humans.

Fish mercury concentrations were determined in a comparable manner between each of the three regions, Manitoba, Quebec, and Newfoundland. Mercury concentrations for fish in reservoirs impounded as part of the Southern Indian Lake/Churchill River Diversion Project in northern Manitoba were based on muscle samples. These samples were analyzed by the procedure described by Hendzel and Jamieson (1976) (Bodaly *et al.*, 1988; Strange *et al.*, 1991; Strange, 1993). Mercury concentrations for fish in La Grande Complex reservoirs were also based on muscle tissue (fillets). The muscle underwent acid digestion (Environment Canada procedure Naquadat method No. 80601-2) and mercury levels were determined by an atomic absorption spectrophotometer (Brouard *et al.*, 1989). Mercury concentrations for Cat Arm Reservoir brook trout and Arctic char and Long Pond Reservoir brook trout and ouananiche (landlocked Atlantic salmon) were determined by the Fish Inspection Lab, Department of Fisheries and Oceans, St. John's, Newfoundland (LeDrew, Fudge Associates Limited, 1992; Buchanan, 1990; 1991; 1993; 1994). Mercury concentrations were determined for fish muscle (fillet) samples using flameless atomic absorption techniques (Uth  *et al.*, 1970; Armstrong and Uth , 1971; Hendzel and Jamieson, 1976). Fish mercury data is presented in Appendix A.

5.3 Model Validation

5.3.1 Definition of the Response Variable

When a reservoir is impounded, it is known that the mercury levels in all biota inhabiting the flooded lakes will increase. In general, fish mercury levels increase quite rapidly following impoundment and it is of interest to predict the change in fish mercury concentrations following impoundment. Also of concern, especially for commercial and native groups, is how high the mercury levels will increase and whether fish body burdens will surpass the Canadian consumption guideline of 0.5 ppm. Therefore, Models I and II (equations 12 and 13) were evaluated on their ability to predict both immediate and maximum fish mercury concentrations. The first ratio was determined based on the first complete sampling period following impoundment. In general, these data were collected for each reservoir approximately three years following impoundment. The second ratio determined was based on the maximum mercury concentration reached following impoundment.

For each model, the preimpoundment mercury concentration was an average, by species, based on the entire sample taken from each location. The mean fish size for each of the samples collected was relatively consistent both within regions (i.e. Manitoba and Quebec), as well as between reservoirs within each region. In cases where there was no preimpoundment fish mercury data, control lakes from the same

area were used.

5.3.2 Validation Procedure

Due to a small data set (i.e. 12 reservoirs), it was decided the most effective use of this limited data would involve successive predictions and revisions rather than using all the data at once to derive a single set of parameter estimates. Parameter estimates were initially derived for each of the three species; northern pike (*Esox lucius*), walleye (*Stizostedion vitreum*), and lake whitefish (*Coregonus clupeaformis*), using the Manitoba data. The parameter estimates were then used to predict the mercury ratio for a single reservoir, La Grande 2 Reservoir in northern Quebec. The value predicted from the model could then be compared to the observed value of the ratio (between postimpoundment and preimpoundment mercury concentrations), for each of the three species. The data collected from La Grande 2 was then combined with the Manitoba data. This procedure increased the sample size and provided revised parameter estimates. These revised parameter estimates were then used to predict the mercury ratio for the next reservoir, La Grande 3. Once again, the predicted value could then be compared with the observed value, known for this reservoir. The same procedure was repeated for the remaining three reservoirs from Quebec for which data had been obtained. The order in which reservoirs were added to increase the sample size and revise parameter estimates were La Grande 2, La Grande 3, La Grande 4, Opinaca, and Caniapiscau. Both Models I and II (equations

12 and 13) were evaluated based on the first complete sampling following impoundment and the peak mercury concentrations reached following impoundment, for each of the three species common between regions (i.e. northern pike, walleye, and lake whitefish).

5.4 Application of the Models -- Newfoundland Predictions

One criterion commonly used to differentiate among competing models is the ability to predict cases not used to develop the model. This criterion can be applied by comparing the predicted and observed values for cases not used in the model development (e.g. Drinkwater and Myers, 1987).

5.4.1 Different Species -- Cat Arm Salmonids

The island of Newfoundland is unique in several ways. Of concern for this study were the differences in food webs between the island and the mainland. Typically, mainland food webs are more complex with many trophic levels while food webs for Newfoundland systems tend to be simpler with fewer trophic levels. For example, Cat Arm Reservoir contains only two fish species, brook trout and Arctic char. In general, there are no forage fish such as cyprinids on the island and fish are forced to feed primarily on benthic invertebrates such as chironomids. Many

freshwater systems contain the threespine stickleback (*Gasterosteus aculeatus*) which may act as a forage fish in some Newfoundland systems. However, Newfoundland systems typically contain brook trout and/or ouananiche (landlocked Atlantic salmon), not many of which reach a size capable of foraging on the threespine stickleback.

It was of interest to know whether the two models developed for mainland reservoirs were able to predict the change in mercury concentrations in fish inhabiting a different type of reservoir ecosystem (i.e. Newfoundland reservoirs). The data collected from Cat Arm Reservoir included preimpoundment mercury data collected for both species (brook trout and Arctic char) inhabiting this reservoir and a postimpoundment monitoring effort.

Current research indicates that the food web is the primary pathway for mercury to fish (Hall *et al.*, 1994). Therefore, when applying a model based on a biological understanding of a system to species that have previously not been included in the analyses, *a priori*, one would use the fish species that most closely resembles the food habits of the species of concern. For this study, there were two species for which not enough data existed to derive parameter estimates, namely brook trout and Arctic char. No evidence of piscivory has been found for species inhabiting Cat Arm Reservoir. Therefore, both species are considered to be primary carnivores. Based on the data collected from Manitoba and Quebec, both northern pike and walleye are piscivorous and are not comparable in food habits to brook trout or Arctic char from Cat Arm Reservoir. However, lake whitefish are also primary carnivores and thus

their trophic level was close to the two species inhabiting Cat Arm. Models I and II (equations 12 and 13) were evaluated based on the first complete sampling period following impoundment and peak mercury concentrations reached following impoundment, for the two species in Cat Arm Reservoir (brook trout and Arctic char) using parameter estimates derived for lake whitefish.

5.4.2 Different Reservoirs -- The Long Pond Prediction

It was also of interest to know if the models developed for predicting the change in fish mercury concentrations following impoundment of a reservoir would predict the change in fish mercury concentrations when altering the size of an existing reservoir. Newfoundland and Labrador Hydro reimpounded one of its insular Newfoundland reservoirs, Long Pond, in 1990, in order to increase the generating capacity of this station. As part of their environmental mandate, Newfoundland and Labrador Hydro agreed to monitor fish mercury levels prior to, during, and after flooding (i.e. the years 1989, 1990, 1991, and 1992). The reimpoundment of Long Pond resulted in the flooding of an additional 10 km² of terrestrial area (L. LeDrew, pers. comm., Newfoundland and Labrador Hydro, St. John's, Newfoundland, 1995). Thus there were mercury data collected before the reimpoundment of this system, for both species inhabiting this reservoir (brook trout and ouananiche or landlocked Atlantic salmon). In addition, the area of the reservoir was known both prior to and after reimpoundment. This allowed a prediction of fish mercury levels following

reimpoundment. Models I and II (equations 12 and 13) were used to predict fish mercury levels during the first complete sampling following reimpoundment and peak mercury concentrations reached following reimpoundment, for the two species inhabiting Long Pond (i.e. brook trout and ouananiche). The two predictions for each species could then be compared to the observed changes in fish mercury concentrations following reimpoundment of Long Pond.

6.0 AVAILABLE DATA ON FISH MERCURY CONCENTRATIONS

Data on fish mercury concentrations came from a variety of sources. Bodaly *et al.* (1984a; 1988), Strange *et al.* (1991), and Strange (1993) reported fish mercury concentrations for reservoirs impounded as part of the Southern Indian Lake/Churchill River Diversion Project. Mercury concentrations for fish in control lakes in northern Manitoba were provided by Johnston (Department of Fisheries and Oceans, Freshwater Institute, Winnipeg, Manitoba, unpublished data). Fish mercury concentrations for reservoirs impounded as part of the La Grande Complex in northern Quebec and control lakes in northern Quebec were provided by Doyon (Groupe Environnement Shooner inc., Quebec City, Quebec, unpublished data). Fish mercury concentrations for Cat Arm Reservoir were reported by LeDrew, Fudge and Associates Limited (1992) and mercury concentrations for fish in Long Pond Reservoir were reported by Buchanan (1990; 1991; 1993; 1994).

6.1 Manitoba

Mean mercury concentrations in northern pike collected during sampling surveys in northern Manitoba reservoirs impounded as part of the Southern Indian Lake/Churchill River Diversion Project are shown in Figures 6 and 7. The most

extensive sampling was conducted on Southern Indian Lake (Figure 6), the most important reservoir commercially and Issett Lake (Figure 7), impounded as part of Notigi reservoir. Fish mercury concentrations rose following impoundment of Southern Indian Lake and remained around 1.0 ppm. The 1992 sampling effort showed that mean mercury concentrations in northern pike began declining towards baseline levels. Preliminary data from the 1994 sampling effort showed that mercury concentrations were approaching baseline levels (R.A. Bodaly, pers. comm., Department of Fisheries and Oceans, Winnipeg, Manitoba, 1995). Mean mercury concentrations for northern pike collected from Issett Lake (Figure 7) rose gradually in the first few years following impoundment and peaked around 1985. In subsequent years, the trend was towards decreasing mean mercury concentrations. It was not possible to determine trends for the data collected from Threepoint, Footprint, Wuskwatim, Notigi or Rat reservoirs due to incomplete sampling efforts.

Mean mercury concentrations for walleye sampled in reservoirs impounded as part of the Southern Indian Lake/Churchill River Diversion Project are shown in Figures 8 and 9. Again, due to sporadic sampling, it was not possible to determine trends for Threepoint, Footprint, Wuskwatim, Notigi or Rat reservoirs. Sampling focused on two major reservoirs, Southern Indian Lake and Issett Lake (part of Notigi reservoir). For walleye sampled in Southern Indian Lake (Figure 8), there was an increase in mean mercury concentrations immediately following impoundment, then a trend towards decreasing concentrations. The trend was different for walleye sampled

from Issett Lake (Figure 9) where the trend was a cycle of increasing and decreasing mean mercury concentrations.

Mean mercury concentrations for lake whitefish sampled in reservoirs impounded as part of the Southern Indian Lake/Churchill River Diversion Project are shown in Figures 10 and 11. As for northern pike and walleye, there were insufficient data to determine trends for Threepoint, Footprint, Wuskwatim, Notigi or Rat reservoirs. Lake whitefish collected from Southern Indian Lake showed a dramatic increase in mean mercury concentrations immediately following impoundment (i.e. between 1975 and 1978) and then a gradual decrease (Figure 10). Lake whitefish in Southern Indian Lake are expected to reach baseline mercury concentrations within 30 years of impoundment (R.A. Bodaly, pers. comm., Department of Fisheries and Oceans, Winnipeg, Manitoba, 1995). A similar trend was observed for lake whitefish collected from Issett Lake (Figure 11) although with more variability than Southern Indian Lake (i.e. Figure 10).

6.2 Quebec

The change in mean mercury concentrations through time for northern pike sampled in Quebec reservoirs is shown in Figure 12. The trends are clearest for the oldest Quebec reservoirs, La Grande 2 and Opinaca. For these reservoirs, there was

a gradual increase in mean mercury concentrations, peaking around 1990 and 1992 for La Grande 2 and Opinaca, respectively. The remaining three reservoirs, La Grande 3, La Grande 4 and Caniapiscou are younger reservoirs and the trends observed for mean mercury concentrations in northern pike from these systems indicate the initial rise. The highest mercury concentration for these reservoirs occurred in the last year of sampling.

Figure 13 shows the mean mercury concentrations through time for walleye sampled in Quebec reservoirs. In the older reservoirs (La Grande 2 and Opinaca) mean mercury concentrations rose following impoundment, peaking around 1988 for La Grande 2 and 1990 for Opinaca. Although mercury levels have started to decline in these reservoirs, it is important to note that the levels are still roughly four times the Canadian consumption guideline of 0.5 ppm. Peak mercury concentrations for walleye in La Grande 3 Reservoir coincided with the last year of sampling.

Mean mercury concentrations for Quebec reservoir lake whitefish are shown in Figure 14. As with lake whitefish sampled in Manitoba reservoirs, this species responded differently than the two piscivorous species previously examined (northern pike and walleye). Even in the youngest of the Quebec reservoirs, lake whitefish have started to decline after reaching their maximum. In all cases, mean mercury concentrations are now below the Canadian consumption guideline of 0.5 ppm mercury.

The temporal trends are similar for each reservoir when each species is

considered separately (Figure 15). From this figure, it can also be seen that the trends observed for northern pike, walleye and lake whitefish were different. Although the trends were similar within species with respect to the changes in mean mercury concentrations, there was evidence of inter-reservoir variability (Figure 16), most notably for the two piscivorous species, northern pike and walleye. Lake whitefish, a non-piscivorous species, followed the same pattern, independent of reservoir. This figure shows mean mercury concentrations plotted against reservoir age for each of the three species examined. Negative numbers indicate the number of years prior to impoundment; a value of -3 represents control lakes.

6.3 Newfoundland

Mean mercury concentrations for Arctic char and brook trout sampled at Cat Arm Reservoir are shown in Figure 17. The 0.5 ppm Canadian Guideline for mercury is also indicated. Cat Arm Reservoir was impounded in 1984, therefore the 1982 data represent preimpoundment mercury concentrations. Mean mercury concentrations peaked around 1990, six years following impoundment, for both species inhabiting this reservoir. The mean mercury concentration for Arctic char surpassed the Canadian limit in 1986, only two years following the impoundment of Cat Arm Lake. Brook trout approached, but never surpassed, the Canadian limit.

Due to the effect of size on fish mercury concentrations, it was of interest to know if the mean mercury concentrations of brook trout or Arctic char (used in the analyses) were unduly influenced by a few, larger fish with extremely high mercury concentrations. For each year of sampling at Cat Arm Reservoir, flesh mercury concentrations were plotted against fork length, for Arctic char (Figure 18) and brook trout (Figure 19). After 1988, Arctic char sampled in Cat Arm demonstrated a relatively strong positive relationship between mercury concentration and fork length. This trend was not apparent for Arctic char prior to sampling in 1988 and was never observed for brook trout sampled at Cat Arm (Figures 18 and 19). Because fish weight is a function of fish length, it was not surprising to find similar relationships between flesh mercury concentration and fish weight for Arctic char (Figure 20) and brook trout (Figure 21). Based on Figures 18 – 21, mean mercury concentrations were representative of the entire sample.

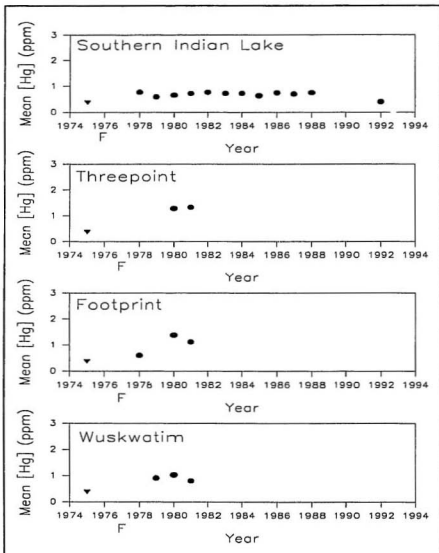

Figure 6 Mean mercury concentrations of northern pike in lakes impounded as part of the Southern Indian Lake/Churchill River Diversion Project. Control lakes (▼) were used as a baseline. Year of flooding (F) is indicated.

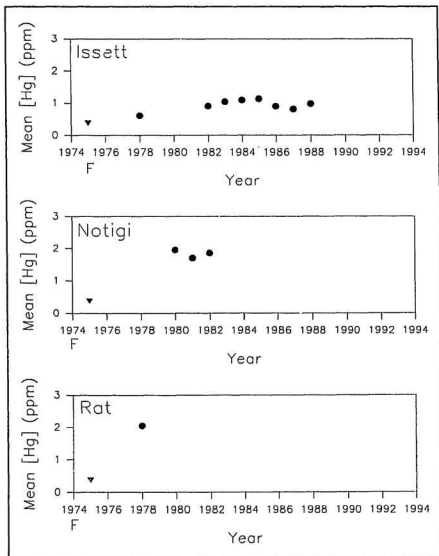

Figure 7 Mean mercury concentrations of northern pike sampled from lakes impounded as part of Notigi Reservoir. Control lakes (▼) were used as a baseline. Year of flooding (F) is also indicated.

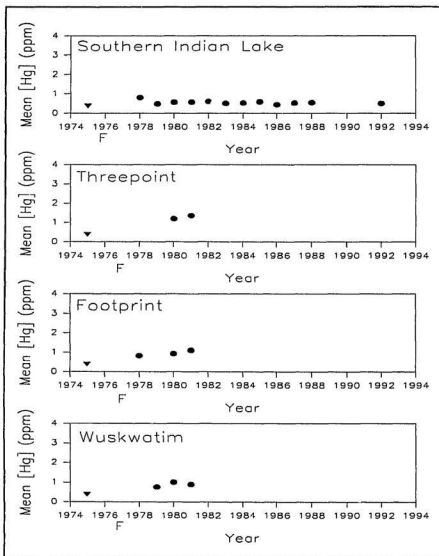

Figure 8 Mean mercury concentrations of walleye sampled from lakes impounded as part of the Southern Indian Lake/Churchill River Diversion Project. Control lakes (▼) were used as a baseline. Year of flooding (F) is also indicated.

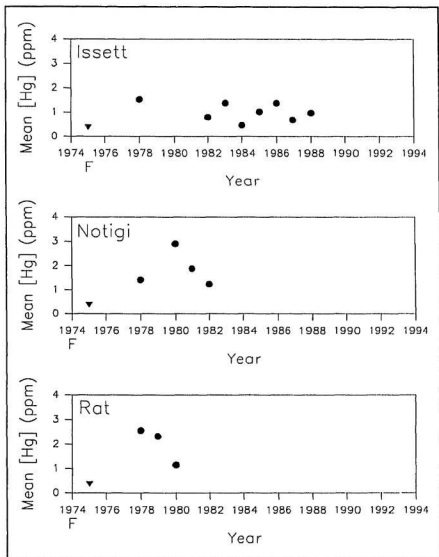

Figure 9 Mean mercury concentrations of walleye sampled from lakes impounded as part of Notigi Reservoir. Control lakes (▼) were used as a baseline. Year of flooding (F) is also indicated.

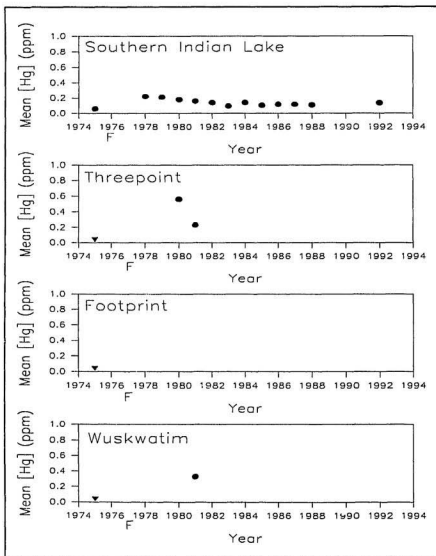

Figure 10 Mean mercury concentrations of lake whitefish sampled from lakes impounded as part of the Southern Indian Lake/Churchill River Diversion Project. Control lakes (▼) were used as a baseline. Year of flooding (F) is also indicated.

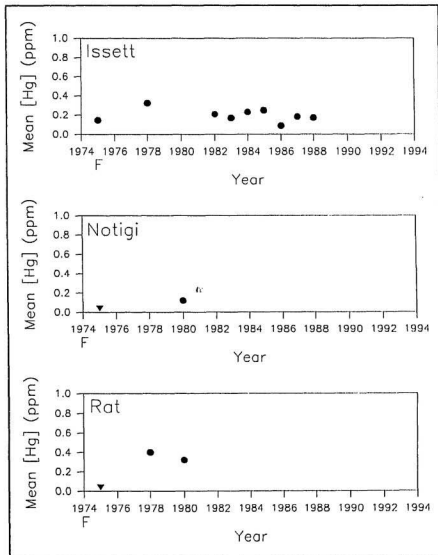

Figure 11 Mean mercury concentrations of lake whitefish sampled from lakes impounded as part of Notigi Reservoir. Control lakes (▼) were used as a baseline. Year of flooding is also indicated.

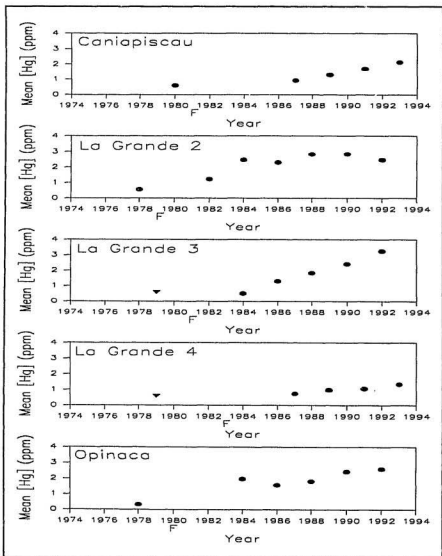

Figure 12 Mean mercury concentrations of northern pike sampled from La Grande Complex reservoirs. Control lakes (▼) were used as a baseline when necessary. Year of flooding (F) is also indicated.

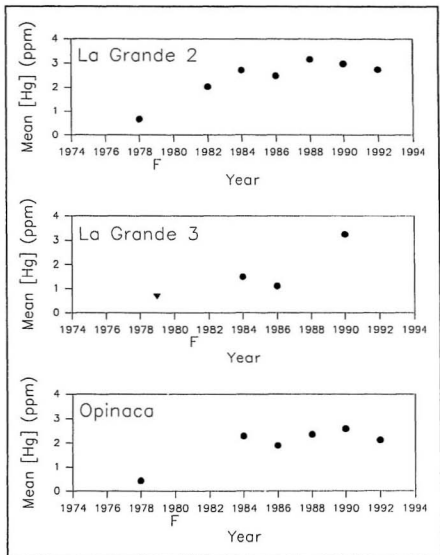

Figure 13 Mean mercury concentrations of walleye sampled from La Grande Complex reservoirs. Control lakes (▼) were used as a baseline when necessary. Year of flooding (F) is also indicated.

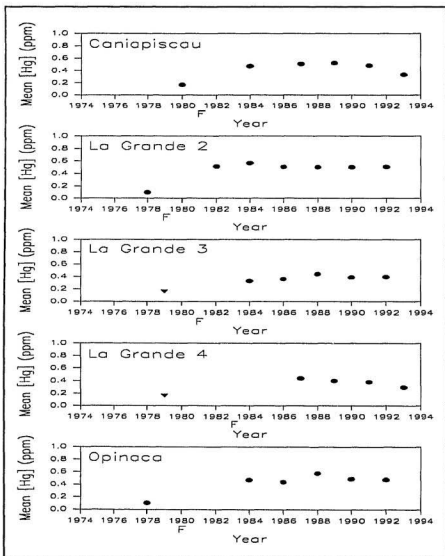

Figure 14 Mean mercury concentrations of lake whitefish sampled from La Grande Complex reservoirs. Control lakes (▼) were used as a baseline when necessary. Year of flooding (F) is also indicated.

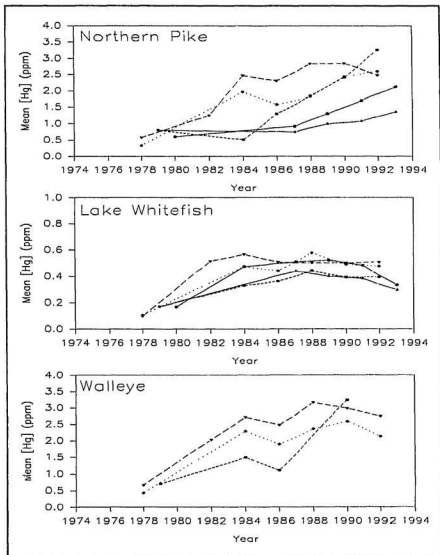

Figure 15 Plots of mean mercury concentrations for northern pike, walleye and lake whitefish for Caniapiscieu (●); La Grande 2 (▼); La Grande 3 (■); La Grande 4 (▲); and Opinaca (◆) Reservoirs.

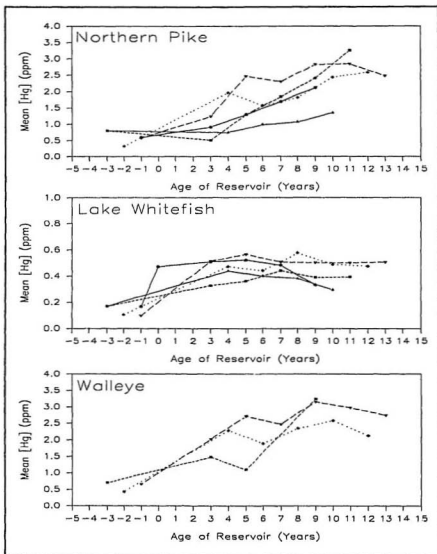

Figure 16 Mean mercury concentrations plotted against reservoir age for northern pike, walleye and lake whitefish for Caniapiscou (●); La Grande 2 (▼); La Grande 3 (■); La Grande 4 (▲); and Opinaca (◆) Reservoirs.

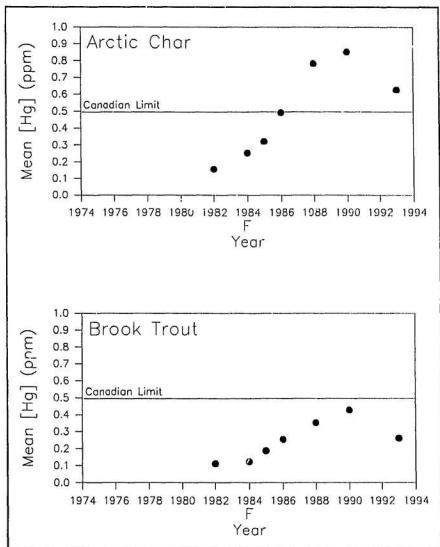

Figure 17 Mean mercury concentrations of Arctic char and brook trout sampled in Cat Arm Reservoir. The year of flooding (F) and the Canadian consumption guideline of 0.5 ppm mercury are shown.

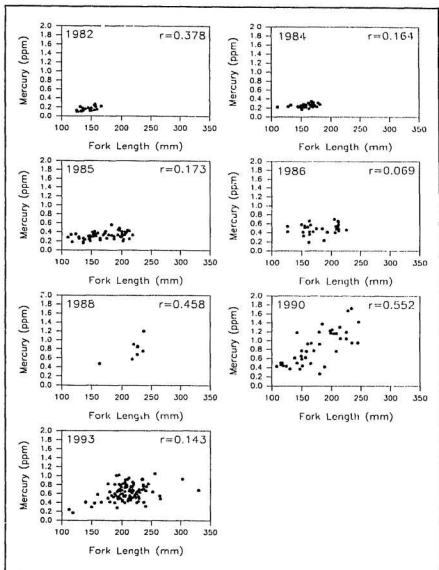

Figure 18 Mercury concentrations plotted against fork length, by year, for Arctic char sampled at Cat Arm Reservoir. The correlation coefficient (r) is also shown.

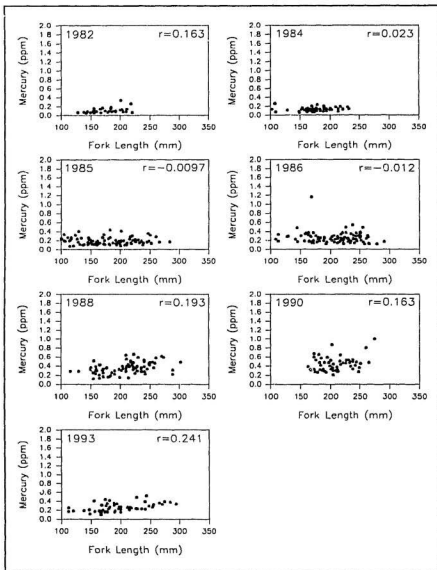

Figure 19 Mercury concentrations plotted against fork length, by year, for brook trout sampled at Cat Arm Reservoir. The correlation coefficient (r) is also shown.

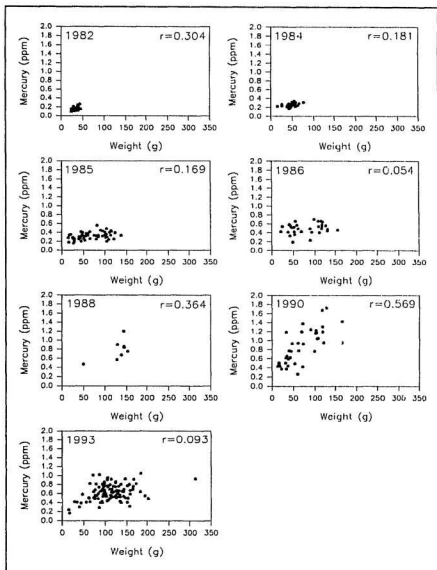

Figure 20 Mercury concentrations plotted against weight, by year, for Arctic char sampled at Cat Arm Reservoir. The correlation coefficient (r) is also shown.

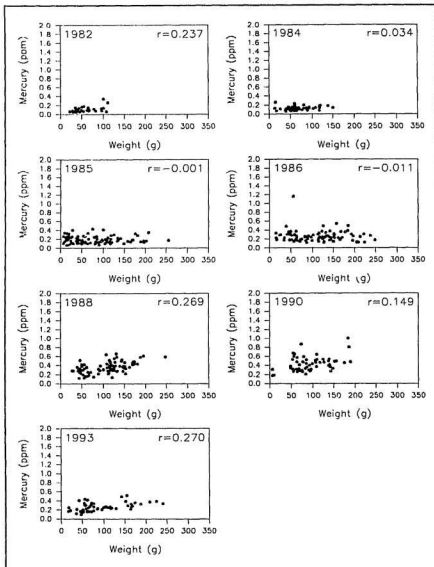

Figure 21 Mercury concentrations plotted against weight, by year, for brook trout sampled at Cat Arm Reservoir. The correlation coefficient (r) is also shown.

7.0 RESULTS

7.1 The Models

7.1.1 Model I (Equation 12)

Skill, defined as the closeness of the predicted and observed values of the mercury ratio, increased for northern pike with Model I for the first sampling period following impoundment (Figure 22A). Model I, based on the Manitoba reservoirs, worked well at predicting the ratio for La Grande 2 Reservoir. Revised models overpredicted the mercury ratio for La Grande 3 and La Grande 4 reservoirs and underpredicted the mercury ratio for Opinaca Reservoir. Skill increased for the fifth Quebec reservoir predicted, Caniapiscou, where a model based on four Quebec reservoirs plus the Manitoba reservoirs was used.

In general the skill of Model I, for peak mercury concentrations in northern pike, improved with the successive addition of Quebec reservoirs to those from Manitoba (Figure 22B). For all but La Grande 4 Reservoir, this model underpredicted the change in fish mercury concentrations. For La Grande 4, the model overpredicted the mercury ratio.

The skill of Model I decreased for walleye sampled during the first period following impoundment (Figure 23A). The predicted and observed values were close for the first two Quebec reservoir predictions, La Grande 2 and La Grande 3. When

a model based on two Quebec reservoirs plus the Manitoba reservoirs was used to predict the mercury ratio for Opinaca Reservoir, the skill of Model I decreased. This model underpredicted the mercury ratio.

The skill of Model I also decreased for walleye sampled at peak mercury concentrations (Figure 23B). The predicted and observed values were close for the La Grande 2 and La Grande 3 predictions but not for the Opinaca prediction. The mercury ratio was underpredicted for La Grande 2 and Opinaca and overpredicted for La Grande 3.

The skill of Model I, for the first sampling period following impoundment for lake whitefish, increased markedly with the successive addition of Quebec reservoirs to those from Manitoba (Figure 24A). The predicted and observed values were close for the last two Quebec reservoirs, Opinaca and Caniapiscau. Parameter estimates from the Manitoba reservoirs underpredicted the mercury ratio for La Grande 2 Reservoir. Revised models overpredicted the mercury ratio for both La Grande 3 and La Grande 4 reservoirs.

The skill of Model I also increased with the successive addition of Quebec reservoirs for lake whitefish sampled during peak mercury concentrations (Figure 24B). Closeness of the predicted and observed values increased for both the Opinaca and Caniapiscau reservoirs. A model based on Manitoba reservoirs underpredicted the observed mercury ratio for La Grande 2. Revised models then overpredicted the mercury ratio for both La Grande 3 and La Grande 4 reservoirs.

Trends in explained variance with increasing sample size depended on species for Model I, for the first sampling period following impoundment (Figure 25A). For walleye the explained variance was constant around 90% and around 80% for lake whitefish. For northern pike the explained variance was initially high (Manitoba and La Grande 2), dropped with the successive addition of the next two reservoirs (La Grande 3 and La Grande 4) and remained constant for the last two Quebec reservoirs predicted, Opinaca and Caniapiscou.

Trends in explained variance with increasing sample size also depended on species for Model I, for peak mercury concentrations (Figure 25B). For walleye, the explained variance decreased slightly. For lake whitefish, the explained variance was constant. Northern pike showed a decrease in explained variance similar to the trend noted for northern pike sampled during the first period following impoundment (e.g. Figure 25A).

The explained variance of Model I was high on a regional basis for the first sampling period following impoundment (Figure 26A). The explained variance of Model I was greater than 70% within each region and again when both regions were combined for northern pike, walleye and lake whitefish. However, regional differences were observed. For each of the three species, the explained variance was higher for Quebec reservoirs than for Manitoba reservoirs or both regions combined.

The explained variance of Model I was also high when applied to peak mercury concentrations on a regional basis (Figure 26B). The explained variance of

Model I was greater than 80% for all three species when each region was considered separately and greater than 75% when the two regions were combined. For this model, the explained variance was similar between regions for each of the three species (northern pike, walleye, and lake whitefish). However, when the regions were combined, two trends emerged. For northern pike and lake whitefish, the explained variance decreased when the two regions were combined. For walleye, the explained variance increased when the two regions were combined.

7.1.2 Model II (Equation 13)

The skill of Model II increased for northern pike, for the first sampling period following impoundment (Figure 27A). Skill was highest for the last reservoir, Caniapiscau, when the predicted and observed values were almost identical. A model based on Manitoba reservoirs was good at predicting the natural logarithm of the mercury ratio for La Grande 2. Subsequent models overpredicted the ratio for both La Grande 3 and La Grande 4 and underpredicted the ratio for Opinaca.

The skill of Model II, for peak mercury concentrations in northern pike, increased (Figure 27B). The predicted and observed values were close when a model based on four Quebec reservoirs plus the Manitoba reservoirs was used to predict the fifth Quebec reservoir, Caniapiscau. For all but the La Grande 4 prediction, this model underpredicted the natural logarithm of the mercury ratio.

The skill of Model II decreased slightly for walleye sampled during the first

sampling period following impoundment (Figure 28A). The first two predictions were close to the observed values but the third prediction had a larger difference between the predicted and observed values. A model based on two Quebec reservoirs plus the Manitoba reservoirs underpredicted the natural logarithm of the mercury ratio for Opinaca Reservoir.

The skill of Model II was constant for walleye sampled at peak mercury concentrations (Figure 28B). This figure shows that the predicted and observed values of the natural logarithm of the mercury ratio were close for each prediction. This model underpredicted the observed value for La Grande 2 and Opinaca and overpredicted the observed value for La Grande 3.

The skill of Model II increased for lake whitefish, for the first sampling following impoundment (Figure 29A). Initially, a model based on the Manitoba reservoirs underpredicted the observed value for La Grande 2 Reservoir. However, the successive addition of Quebec reservoirs improved the skill of this model as the predicted and observed values were close for La Grande 3, La Grande 4, Opinaca and Caniapiscou reservoirs.

The skill of Model II increased for lake whitefish sampled during peak mercury concentrations (Figure 29B). A model based on the Manitoba reservoirs underpredicted the observed value for La Grande 2 Reservoir. The predicted and observed values were close for the remaining four reservoirs from Quebec, La Grande 3, La Grande 4, Opinaca and Caniapiscou.

Changes in explained variance for Model II depended on species for the first sampling period following impoundment (Figure 30A). The explained variance for walleye remained constant. For lake whitefish, the explained variance of this model initially decreased slightly (La Grande 2) then increased with each successive addition of Quebec reservoirs. For northern pike, the explained variance increased when La Grande 2 Reservoir was added, decreased substantially with the successive addition of the next two Quebec reservoirs (La Grande 3 and La Grande 4), and increased slightly with the successive addition of the two remaining Quebec reservoirs (Opinaca and Caniapiscou).

Trends in the explained variance with increasing sample size with Model II depended on species for peak mercury concentrations (Figure 30B). The explained variance for lake whitefish was constant. For walleye, the explained variance decreased slightly with the successive addition of each reservoir from Quebec. For northern pike, the explained variance decreased.

Regional trends in the explained variance of Model II depended on species when applied to the first sampling period following impoundment (Figure 31A). The explained variance was greater than 80% for walleye and lake whitefish for both Manitoba and Quebec reservoirs. For northern pike the explained variance was around 80% for Manitoba reservoirs and around 70% for Quebec reservoirs. When the two regions were combined, the explained variance for walleye and lake whitefish remained high at around 80%. For northern pike, the explained variance decreased to

around 55%.

Regional trends in explained variance of Model II also depended on species when applied to peak mercury concentrations (Figure 31B). The explained variance was high for northern pike, walleye and lake whitefish both within Manitoba and Quebec and when the two regions were combined. Explained variances were comparable between regions for walleye and lake whitefish. For northern pike, the explained variance decreased when the two regions were combined.

7.2 Equations with Parameter Estimates -- Models I and II (Equations 12 and 13)

Parameter estimates for Model I (equation 12) were derived for each of the three species (northern pike, walleye, and lake whitefish) for Manitoba reservoirs, Quebec reservoirs and all the reservoirs combined for both the first sampling period following impoundment (equations 14 – 22) and peak mercury concentrations (equations 23 – 31).

MANITOBA: FIRST SAMPLING FOLLOWING IMPOUNDMENT

$$\text{Northern Pike} \quad R_M = 1.305 D + 2.480 \times 10^{-7} E \quad (14)$$

$$\text{Walleye} \quad R_M = 0.846 D + 2.951 \times 10^{-7} E \quad (15)$$

Lake Whitefish $R_M = 7.504 D + 3.060 \times 10^{-7} E$ (16)

QUEBEC: FIRST SAMPLING FOLLOWING IMPOUNDMENT

Northern Pike $R_M = 25.800 D + 1.000 \times 10^{-8} E$ (17)

Walleye $R_M = 16.325 D + 2.200 \times 10^{-7} E$ (18)

Lake Whitefish $R_M = 10.948 D + 2.600 \times 10^{-7} E$ (19)

COMBINED: FIRST SAMPLING FOLLOWING IMPOUNDMENT

Northern Pike $R_M = 1.666 D + 2.300 \times 10^{-7} E$ (20)

Walleye $R_M = 0.892 D + 3.151 \times 10^{-7} E$ (21)

Lake Whitefish $R_M = 7.576 D + 2.970 \times 10^{-7} E$ (22)

MANITOBA: MAXIMUM MERCURY CONCENTRATIONS

$$\text{Northern Pike} \quad R_M = 1.960 D + 2.830 \times 10^{-7} E \quad (23)$$

$$\text{Walleye} \quad R_M = 0.937 D + 3.792 \times 10^{-7} E \quad (24)$$

$$\text{Lake Whitefish} \quad R_M = 7.568 D + 3.550 \times 10^{-7} E \quad (25)$$

QUEBEC: MAXIMUM MERCURY CONCENTRATIONS

$$\text{Northern Pike} \quad R_M = 29.872 D + 1.900 \times 10^{-7} E \quad (26)$$

$$\text{Walleye} \quad R_M = 14.227 D + 3.300 \times 10^{-7} E \quad (27)$$

$$\text{Lake Whitefish} \quad R_M = 7.693 D + 2.700 \times 10^{-7} E \quad (28)$$

COMBINED: MAXIMUM MERCURY CONCENTRATIONS

$$\text{Northern Pike} \quad R_M = 2.088 D + 3.320 \times 10^{-7} E \quad (29)$$

$$\text{Walleye} \quad R_M = 0.962 D + 4.004 \times 10^{-7} E \quad (30)$$

$$\text{Lake Whitefish} \quad R_M = 14.177 D + 3.430 \times 10^{-7} E \quad (31)$$

Similarly, parameter estimates for Model II (equation 13) were derived for each of the three species for Manitoba reservoirs, Quebec reservoirs and all the reservoirs combined for both the first sampling period following impoundment (equations 32 – 40) and peak mercury concentrations (equations 41 – 49).

MANITOBA: FIRST SAMPLING FOLLOWING IMPOUNDMENT

$$\text{Northern Pike} \quad R_M = e \quad (0.451 D + 7.850 \times 10^{-8} E) \quad (32)$$

$$\text{Walleye} \quad R_M = e \quad (0.245 D + 9.830 \times 10^{-8} E) \quad (33)$$

$$\text{Lake Whitefish} \quad R_M = e \quad (1.911 D + 8.500 \times 10^{-8} E) \quad (34)$$

QUEBEC: FIRST SAMPLING FOLLOWING IMPOUNDMENT

$$\text{Northern Pike} \quad R_M = e \quad (8.969 D + 2.700 \times 10^{-8} E) \quad (35)$$

$$\text{Walleye} \quad R_M = e \quad (4.308 D + 8.800 \times 10^{-8} E) \quad (36)$$

$$\text{Lake Whitefish} \quad R_M = e \quad (3.799 D + 8.700 \times 10^{-8} E) \quad (37)$$

COMBINED: FIRST SAMPLING FOLLOWING IMPOUNDMENT

$$\text{Northern Pike} \quad R_M = e \quad (0.616 D + 6.280 \times 10^{-8} E) \quad (38)$$

$$\text{Walleye} \quad R_M = e \quad (0.249 D + 1.056 \times 10^{-7} E) \quad (39)$$

$$\text{Lake Whitefish} \quad R_M = e \quad (1.922 D + 9.100 \times 10^{-8} E) \quad (40)$$

MANITOBA: MAXIMUM MERCURY CONCENTRATIONS

$$\text{Northern Pike} \quad R_M = e \quad (0.743 D + 9.430 \times 10^{-8} E) \quad (41)$$

$$\text{Walleye} \quad R_M = e \quad (0.451 D + 1.122 \times 10^{-7} E) \quad (42)$$

$$\text{Lake Whitefish} \quad R_M = e \quad (1.937 D + 9.800 \times 10^{-8} E) \quad (43)$$

QUEBEC: MAXIMUM MERCURY CONCENTRATIONS

$$\text{Northern Pike} \quad R_M = e^{(7.477 D + 7.200 \times 10^{-8} E)} \quad (44)$$

$$\text{Walleye} \quad R_M = e^{(3.358 D + 1.180 \times 10^{-7} E)} \quad (45)$$

$$\text{Lake Whitefish} \quad R_M = e^{(4.331 D + 9.400 \times 10^{-8} E)} \quad (46)$$

COMBINED: MAXIMUM MERCURY CONCENTRATIONS

$$\text{Northern Pike} \quad R_M = e^{(0.774 D + 1.061 \times 10^{-7} E)} \quad (47)$$

$$\text{Walleye} \quad R_M = e^{(0.443 D + 1.208 \times 10^{-7} E)} \quad (48)$$

$$\text{Lake Whitefish} \quad R_M = e^{(1.958 D + 1.040 \times 10^{-7} E)} \quad (49)$$

7.3 Newfoundland Predictions

7.3.1 Different Species -- Cat Arm Salmonids

Model I failed to predict the mercury ratio for brook trout (Figure 32) or Arctic char (Figure 33) in Cat Arm either for the first sampling period following

impoundment or peak mercury concentrations. The parameter estimates derived for lake whitefish from each of Manitoba reservoirs, Quebec reservoirs, and all the reservoirs combined, greatly overpredicted the observed mercury ratio.

Model II overpredicted the observed ratio for brook trout (Figure 34) or Arctic char (Figure 35) in Cat Arm for the first sampling period following impoundment or peak mercury concentrations. The parameter estimates derived for lake whitefish from Manitoba reservoirs, Quebec reservoirs and all the reservoirs combined, overpredicted the observed ratio.

7.3.2 Different Reservoirs -- The Long Pond Prediction

Mean mercury concentrations of ouananiche and brook trout in Long Pond Reservoir before and after reimpoundment are shown in Figure 36. Model I failed to predict the mercury ratio for brook trout (Figure 37) or ouananiche (Figure 38) in Long Pond for the first sampling period following reimpoundment or peak mercury concentrations following reimpoundment. Parameter estimates derived for lake whitefish from each of Manitoba reservoirs, Quebec reservoirs, and all the reservoirs combined, overpredicted the observed mercury ratio.

Model II failed to predict the natural logarithm of the mercury ratio for brook trout (Figure 39) or ouananiche (Figure 40) in Long Pond for the first sampling period following reimpoundment or peak mercury concentrations. Parameter estimates derived for lake whitefish from Manitoba reservoirs, Quebec reservoirs, and

all the reservoirs combined, overpredicted the observed ratio.

7.4 Revision of Models I and II

A close look at the parameter estimates for the three original species used in these analyses (northern pike, walleye, and lake whitefish) provided some insight into the problem of large overpredictions. Changes in fish mercury concentrations have been related to both a dilution term and an enrichment term. Given that the food chain is the primary pathway for mercury accumulation in fish (e.g. Hall *et al.*, 1994), one would expect the dilution term to be negligible in these models. Instead, the dilution term was dictating the outcome of Models I and II (i.e. equations 14 – 49).

Both models were revised by eliminating the dilution term. Equation 12 becomes:

$$R_M = b_{E3}E \quad (50)$$

where $E = (A_R - A_L) b_V^{-1} A_R^{-1.321}$ and b_{E3} is an estimate of $k_1 c_3$ (equation 8).

Similarly, equation 13 becomes:

$$\ln(R_M) = b_{E4}E \quad (51)$$

where b_{D4} is an estimate of k_2c_8 (equation 11).

These two new models were evaluated following the same procedure as Model I and Model II.

7.5 The Revised Models

7.5.1 Model III (Equation 50)

The skill of Model III for northern pike increased with the successive addition of Quebec reservoirs for the first sampling period following impoundment (Figure 41A). The predicted and observed values were close for the first prediction, La Grande 2. The predicted and observed values were also close when a model based on four Quebec reservoirs plus the Manitoba reservoirs was used to predict the fifth Quebec reservoir, Caniapiscau. Revised models overpredicted the mercury ratio for both La Grande 3 and La Grande 4 and underpredicted the mercury ratio for Opinaca Reservoir.

The skill of Model III for northern pike increased for peak mercury concentrations (Figure 41B). In general, the difference between predicted and observed values decreased as reservoirs were added in succession. For all but La Grande 4 Reservoir, this model underpredicted the change in fish mercury concentrations.

The skill of Model III for walleye decreased when applied to the first sampling period following impoundment (Figure 42A). The predicted and observed values were close for both the La Grande 2 and La Grande 3 predictions. The difference between predicted and observed values was greater for the Opinaca prediction. A model based on two Quebec reservoirs plus the Manitoba reservoirs underpredicted this ratio.

The skill of Model III remained constant for walleye when applied to peak mercury concentrations (Figure 42B). This model underpredicted the observed mercury ratio for La Grande 2 and Opinaca and overpredicted the ratio for La Grande 3.

The skill of Model III for lake whitefish increased with the successive addition of reservoirs for the first sampling period following impoundment (Figure 43A). The difference between the predicted and observed values was less for the last two reservoirs, Opinaca and Caniapiscau. This figure shows that a model based on the Manitoba reservoirs underpredicted La Grande 2 Reservoir. Revised models overpredicted the mercury ratio for La Grande 3 and La Grande 4 reservoirs and underpredicted the ratio for Opinaca and Caniapiscau.

The skill of Model III for lake whitefish increased for peak mercury concentrations (Figure 43B). The predicted and observed values were closer for the last two Quebec reservoirs predicted, Opinaca and Caniapiscau. For this model, the observed values for La Grande 2, Opinaca and Caniapiscau were underpredicted while

the observed values for La Grande 3 and La Grande 4 were overpredicted.

Trends in explained variance with increasing sample size depended on species for the first sampling period following impoundment (Figure 44A). For walleye, the explained variance remained constant at around 90% when reservoirs from Quebec were added in succession. For lake whitefish, the explained variance increased with the successive addition of Quebec reservoirs. For northern pike, the explained variance was initially high (Manitoba and La Grande 2), dropped with the successive addition of the next two reservoirs (La Grande 3 and La Grande 4) and remained constant with the successive addition of the remaining two Quebec reservoirs (Opinaca and Caniapiscou).

Trends in explained variance with increasing sample size also depended on species for peak mercury concentrations (Figure 44A). The explained variance for walleye remained constant (greater than 90%) as Quebec reservoirs were added in succession. The explained variance for lake whitefish increased as reservoirs from Quebec were added in succession. For northern pike, the trend in explained variance was similar to the one observed when Model III was applied to the first sampling period following impoundment (i.e. Figure 44A). In general, the explained variance was higher for each of the three species when Model III was applied to peak mercury concentrations than when this model was applied to the first sampling period following impoundment.

Regional trends in explained variance of Model III depended on species for the

first sampling period following impoundment (Figure 45A). For each of the three species the explained variance of Model III was generally greater than 70% within each region (i.e. Manitoba and Quebec). The exceptions were lake whitefish in Manitoba (explained variance around 45%) and northern pike in Quebec (explained variance around 50%). When the two regions were combined, trends differed for each species. For walleye, the explained variance remained unchanged. For lake whitefish, the explained variance was higher than Manitoba reservoirs but substantially lower than Quebec reservoirs. For northern pike the explained variance was higher than Quebec reservoirs but lower than Manitoba reservoirs.

Regional trends in explained variance for Model III also depended on species for peak mercury concentrations (Figure 45B). The variance explained by this model was greater than 70% for each of the three species when the regions were considered separately. The exception was Manitoba lake whitefish, which had an explained variance around 50%. Three different trends were observed when the regions were combined. For walleye, the explained variance remained constant. The explained variance for lake whitefish was slightly higher than Manitoba reservoirs but substantially lower than Quebec reservoirs. For northern pike, the explained variance was higher than Quebec reservoirs but less than Manitoba reservoirs.

7.5.2 Model IV (Equation 51)

The skill of Model IV for northern pike increased for the first sampling period

following impoundment (Figure 46A) and remained constant, except for the last prediction where skill increased, for peak mercury concentrations (Figure 46B). As reservoirs were added in succession, the predicted and observed values became closer for the first sampling period following impoundment. For the last prediction, Caniapiscou, the observed and predicted values were almost identical when a model based on four Quebec reservoirs plus the Manitoba reservoirs was used. For peak mercury concentrations, this model underpredicted the observed value, with the exception of La Grande 4.

The skill of Model IV for walleye decreased for the first sampling period following impoundment (Figure 47A) and remained constant for peak mercury concentrations (Figure 47B). For the first sampling period following impoundment, the observed and predicted values were close for the first two predictions. This model underpredicted the observed ratio for La Grande 2 and overpredicted the ratio for La Grande 3. The difference between predicted and observed values was greater for the last prediction, Opinaca. For peak mercury concentrations the predicted and observed values were close in each case.

The skill of Model IV for lake whitefish increased for the first sampling period following impoundment (Figure 48A) and peak mercury concentrations (Figure 48B). Skill increased for the second reservoir prediction, La Grande 3 and with the successive addition of each Quebec reservoir. The predicted and observed values were close for La Grande 3, La Grande 4, Opinaca and Caniapiscou reservoirs.

Trends in explained variance for Model IV with increasing sample size depended on species for the first sampling period following impoundment (Figure 49A). For walleye, the explained variance remained constant around 95%. For lake whitefish, the explained variance increased with the successive addition of reservoirs. The explained variance for northern pike increased with the addition of La Grande 2, decreased substantially with the successive addition of La Grande 3 and La Grande 4, and increased with the addition of the remaining two Quebec reservoirs (Opinaca and Caniapiscou).

Trends in explained variance for Model IV with increasing sample size also depended on species for peak mercury concentrations (Figure 49B). The explained variance for lake whitefish increased with the successive addition of Quebec reservoirs. For walleye, the explained variance remained constant around 95%. For northern pike, the explained variance remained constant around 90% when the first two Quebec reservoirs (La Grande 2 and La Grande 3) were added to those from Manitoba. For the La Grande 4 prediction, the explained variance dropped to about 80%. This level of explained variance was maintained for the remaining two reservoirs.

Regional trends in explained variance for Model IV depended on species for the first sampling period following impoundment (Figure 50A). In general, within each region, the explained variance was high (greater than 70%) for each species. For Manitoba lake whitefish, the explained variance was around 50% and for Quebec

northern pike the explained variance was around 20%. Three trends were observed when the regions were combined. For walleye, the explained variance remained constant around 90%. For lake whitefish, the explained variance was greater than Manitoba reservoirs but substantially lower than Quebec reservoirs. For northern pike, the explained variance was substantially lower than Manitoba reservoirs but substantially higher than Quebec reservoirs.

Regional trends in explained variance for Model IV for peak mercury concentrations depended on species (Figure 50B). For walleye and northern pike, the explained variances were comparable between Manitoba and Quebec and when the two regions were combined. For lake whitefish, the explained variance of the combined reservoirs was greater than Manitoba reservoirs but less than Quebec reservoirs.

6.6 Equations with Parameter Estimates for Models III and IV (Equations 50 and 51)

Parameter estimates for Model III were derived for each of the three species based on Manitoba reservoirs, Quebec reservoirs and all the reservoirs combined. Parameter estimates were made for both the first sampling period following impoundment (equations 52 – 60) and peak mercury concentrations (equations 61 – 69).

MANITOBA: FIRST SAMPLING FOLLOWING IMPOUNDMENT

$$\text{Northern Pike} \quad R_M = 2.728 \times 10^{-7} E \quad (52)$$

$$\text{Walleye} \quad R_M = 3.114 \times 10^{-7} E \quad (53)$$

$$\text{Lake Whitefish} \quad R_M = 4.111 \times 10^{-7} E \quad (54)$$

QUEBEC: FIRST SAMPLING FOLLOWING IMPOUNDMENT

$$\text{Northern Pike} \quad R_M = 2.260 \times 10^{-7} E \quad (55)$$

$$\text{Walleye} \quad R_M = 3.920 \times 10^{-7} E \quad (56)$$

$$\text{Lake Whitefish} \quad R_M = 3.461 \times 10^{-7} E \quad (57)$$

COMBINED: FIRST SAMPLING FOLLOWING IMPOUNDMENT

$$\text{Northern Pike} \quad R_M = 2.555 \times 10^{-7} E \quad (58)$$

Walleye $R_M = 3.304 \times 10^{-7} \text{ E}$ (59)

Lake Whitefish $R_M = 3.860 \times 10^{-7} \text{ E}$ (60)

MANITOBA: MAXIMUM MERCURY CONCENTRATIONS

Northern Pike $R_M = 3.203 \times 10^{-7} \text{ E}$ (61)

Walleye $R_M = 3.973 \times 10^{-7} \text{ E}$ (62)

Lake Whitefish $R_M = 4.609 \times 10^{-7} \text{ E}$ (63)

QUEBEC: MAXIMUM MERCURY CONCENTRATIONS

Northern Pike $R_M = 4.377 \times 10^{-7} \text{ E}$ (64)

Walleye $R_M = 4.805 \times 10^{-7} \text{ E}$ (65)

Lake Whitefish $R_M = 3.900 \times 10^{-7} \text{ E}$ (66)

COMBINED: MAXIMUM MERCURY CONCENTRATIONS

$$\text{Northern Pike} \quad R_M = 3.636 \times 10^{-7} \text{ E} \quad (67)$$

$$\text{Walleye} \quad R_M = 4.169 \times 10^{-7} \text{ E} \quad (68)$$

$$\text{Lake Whitefish} \quad R_M = 4.335 \times 10^{-7} \text{ E} \quad (69)$$

Parameter estimates for Model IV were derived for each of the three species based on Manitoba reservoirs, Quebec reservoirs and all the reservoirs combined. Parameter estimates were derived for both the first sampling period following impoundment (equations 70 – 78) and peak mercury concentrations (equations 79 – 87).

MANITOBA: FIRST SAMPLING FOLLOWING IMPOUNDMENT

$$\text{Northern Pike} \quad R_M = e \quad (8.720 \times 10^{-8} \text{ E}) \quad (70)$$

$$\text{Walleye} \quad R_M = e \quad (1.030 \times 10^{-7} \text{ E}) \quad (71)$$

$$\text{Lake Whitefish} \quad R_M = e \quad (1.114 \times 10^{-7} \text{ E}) \quad (72)$$

QUEBEC: FIRST SAMPLING FOLLOWING IMPOUNDMENT

$$\text{Northern Pike} \quad R_M = c \quad (4.660 \times 10^{-3} E) \quad (73)$$

$$\text{Walleye} \quad R_M = c \quad (1.320 \times 10^{-7} E) \quad (74)$$

$$\text{Lake Whitefish} \quad R_M = c \quad (1.182 \times 10^{-7} E) \quad (75)$$

COMBINED: FIRST SAMPLING FOLLOWING IMPOUNDMENT

$$\text{Northern Pike} \quad R_M = c \quad (7.220 \times 10^{-8} E) \quad (76)$$

$$\text{Walleye} \quad R_M = c \quad (1.099 \times 10^{-7} E) \quad (77)$$

$$\text{Lake Whitefish} \quad R_M = c \quad (1.141 \times 10^{-7} E) \quad (78)$$

MANITOBA: MAXIMUM MERCURY CONCENTRATIONS

$$\text{Northern Pike} \quad R_M = c \quad (1.086 \times 10^{-7} E) \quad (79)$$

$$\text{Walleye} \quad R_M = c \quad (1.209 \times 10^{-7} E) \quad (80)$$

$$\text{Lake Whitefish} \quad R_M = e \quad (1.256 \times 10^{-7} \text{ E}) \quad (81)$$

QUEBEC: MAXIMUM MERCURY CONCENTRATIONS

$$\text{Northern Pike} \quad R_M = e \quad (1.337 \times 10^{-7} \text{ E}) \quad (82)$$

$$\text{Walleye} \quad R_M = e \quad (1.528 \times 10^{-7} \text{ E}) \quad (83)$$

$$\text{Lake Whitefish} \quad R_M = e \quad (1.301 \times 10^{-7} \text{ E}) \quad (84)$$

COMBINED: MAXIMUM MERCURY CONCENTRATIONS

$$\text{Northern Pike} \quad R_M = e \quad (1.179 \times 10^{-7} \text{ E}) \quad (85)$$

$$\text{Walleye} \quad R_M = e \quad (1.285 \times 10^{-7} \text{ E}) \quad (86)$$

$$\text{Lake Whitefish} \quad R_M = e \quad (1.274 \times 10^{-7} \text{ E}) \quad (87)$$

7.7 Newfoundland Predictions Using Models III and IV

7.7.1 Different Species -- Cat Arm Salmonids

Model III was good at predicting the mercury ratio for brook trout (Figure 51) and Arctic char (Figure 52) in Cat Arm for the first sampling period following impoundment and peak mercury concentrations. The predicted and observed values were close when parameter estimates were made for lake whitefish from each of Manitoba reservoirs, Quebec reservoirs, and all the reservoirs combined.

Model IV was good at predicting the natural logarithm of the mercury ratio for brook trout in Cat Arm for both the first sampling period following impoundment (Figure 53A) and peak mercury concentrations (Figure 53B). The predicted and observed values were close. For the first sampling period following impoundment the observed values were overpredicted and for peak mercury concentrations the observed values were underpredicted.

Model IV was able to predict the natural logarithm of the mercury ratio for Arctic char in Cat Arm for the first sampling period following impoundment (Figure 54A). The prediction was close for peak mercury concentrations (Figure 54B). The observed ratio was predicted by the parameter estimates derived for lake whitefish from each of Manitoba reservoirs, Quebec reservoirs, and all reservoirs combined, for the first sampling period following impoundment. For peak mercury concentrations, the observed values were slightly underpredicted.

7.7.2 Different Reservoirs -- The Long Pond Prediction

Model III was good at predicting the mercury ratio for brook trout (Figure 55) and ouananiche (Figure 56) in Long Pond for the first sampling following reimpoundment and peak mercury concentrations after reimpoundment. The predicted and observed values were close when parameter estimates for Manitoba reservoirs, Quebec reservoirs, and all the reservoirs combined, were used. The observed values were slightly underpredicted by this model.

Model IV was good at predicting the natural logarithm of the mercury ratio for brook trout in Long Pond for both the first sampling period following reimpoundment (Figure 57A) and peak mercury concentrations (Figure 57B). The predicted and observed values were close for the first sampling period and identical for peak mercury concentrations.

Model IV was also good at predicting the natural logarithm of the mercury ratio for ouananiche in Long Pond for both the first sampling period following reimpoundment (Figure 58A) and peak mercury concentrations (Figure 58B). The observed values were slightly overpredicted by parameter estimates from Manitoba reservoirs, Quebec reservoirs and all the reservoirs combined.

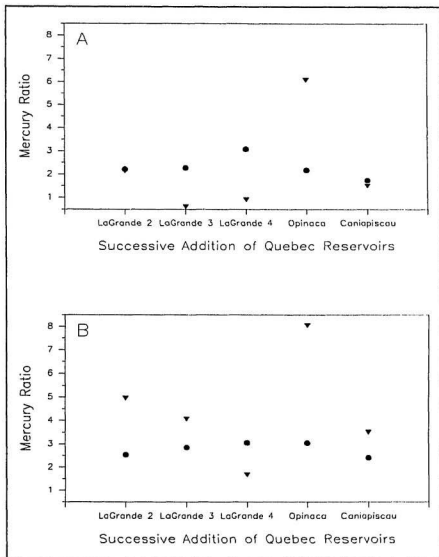

Figure 22 Predicted (•) and observed (▼) values of the mercury ratio for northern pike, for Model I using: (A) the first sampling following impoundment; and (B) the peak mercury concentration.

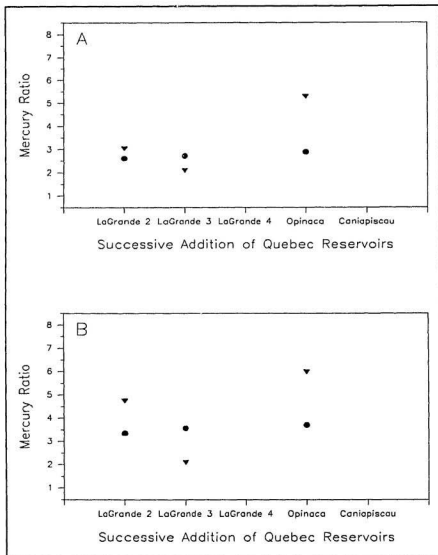

Figure 23 Predicted (●) and observed (▼) values of the mercury ratio for walleye, for Model I using: (A) the first sampling following impoundment; and (B) the peak mercury concentration.

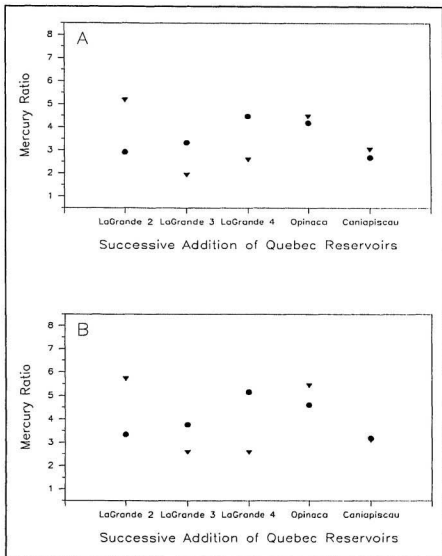

Figure 24 Predicted (•) and observed (▼) values of the mercury ratio for lake whitefish, for Model I using: (A) the first sampling following impoundment; and (B) the peak mercury concentration.

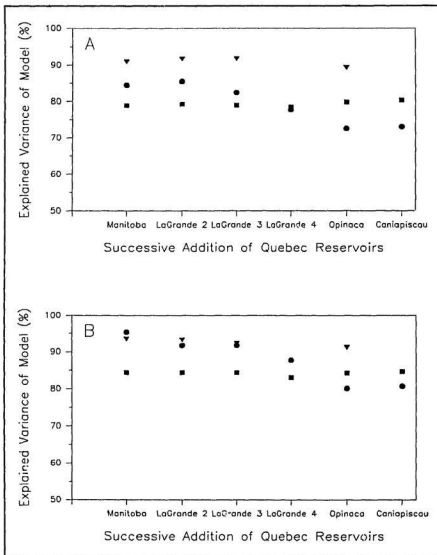

Figure 25 Explained variance of Model I for northern pike (•), walleye (▼), and lake whitefish (■) plotted by reservoir using: (A) the first sampling following impoundment; and (B) the peak mercury concentration.

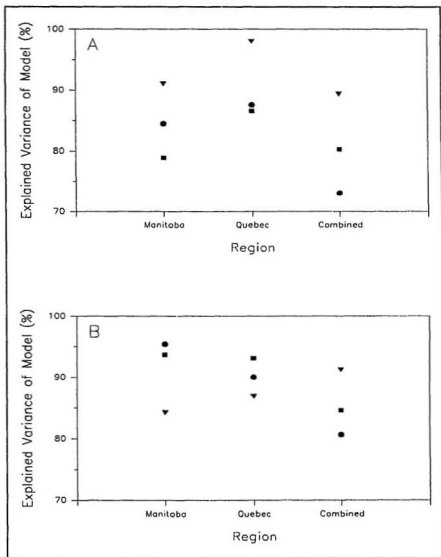

Figure 26 Explained variance of Model I for northern pike (●), walleye (▼), and lake whitefish (■) by region and when combined for: (A) the first sampling following impoundment; and (B) the peak mercury concentration.

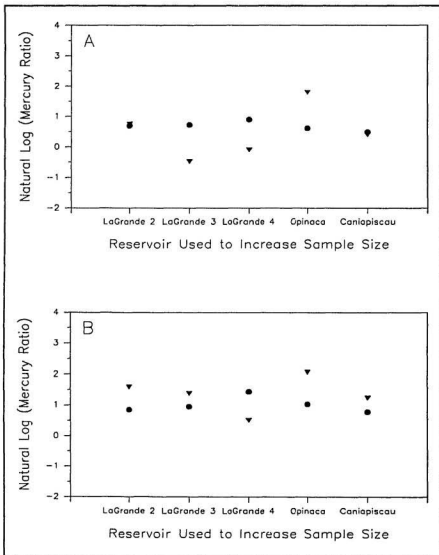

Figure 27 Predicted (•) and observed (▼) values of the natural logarithm of the mercury ratio for northern pike, using Model II for: (A) the first sampling period following impoundment; and (B) the peak mercury concentration.

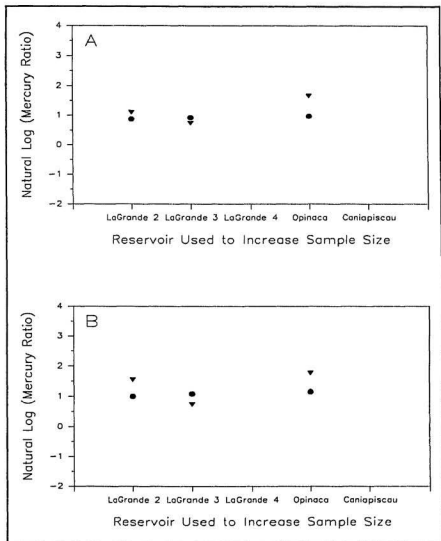

Figure 28 Predicted (●) and observed (▼) values of the natural logarithm of the mercury ratio for walleye, using Model II for: (A) the first sampling period following impoundment; and (B) the peak mercury concentrations.

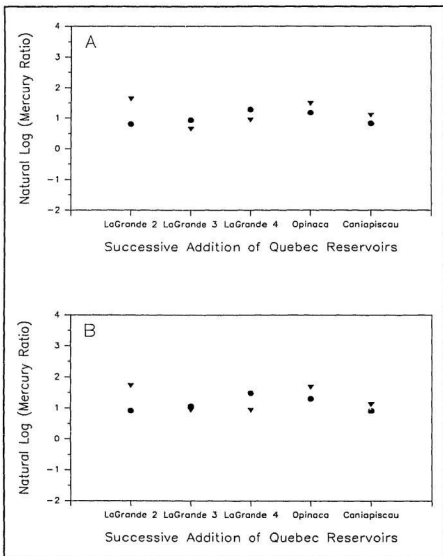

Figure 29 Predicted (•) and observed (▼) values of the natural logarithm of the mercury ratio for lake whitefish, for Model II using: (A) the first sampling period following impoundment; and (B) the peak mercury concentrations.

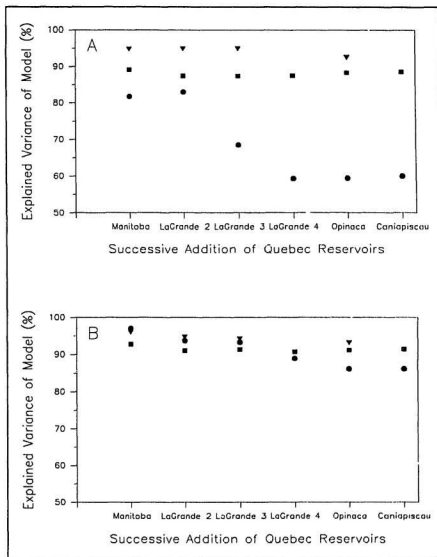

Figure 30 Explained variance of Model II for northern pike (●), walleye (▼), and lake whitefish (■), by reservoir for: (A) the first sampling period following impoundment; and (B) the peak mercury concentrations.

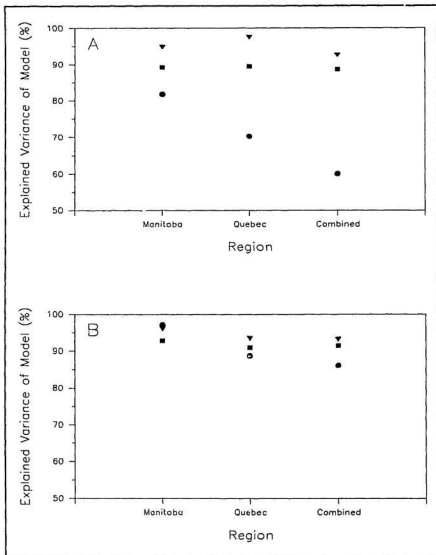

Figure 31 Explained variance of Model II for northern pike (•), walleye (▼), and lake whitefish (■), for each region and when combined for: (A) the first sampling following impoundment; and (B) the peak mercury concentrations.

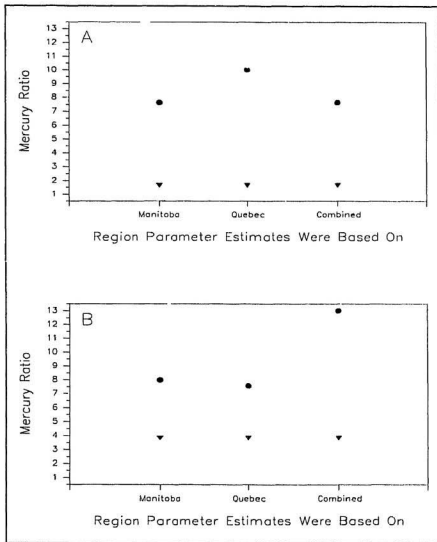

Figure 32 Predicted (●) and observed (▼) values of the mercury ratio for brook trout in Cai Arm Reservoir using Model I for: (A) the first sampling following impoundment; and (B) the peak mercury concentration.

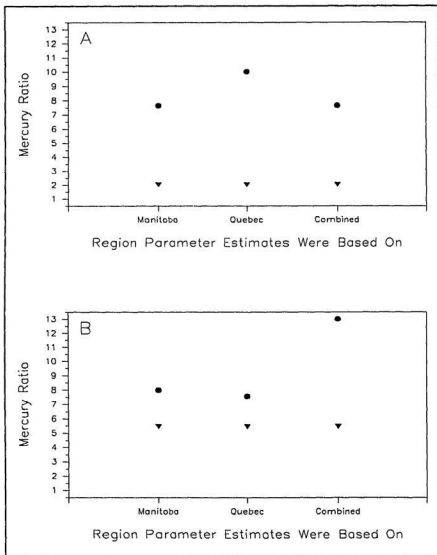

Figure 33 Predicted (•) and observed (▼) values of the mercury ratio for Arctic char in Cat Arm Reservoir using Model I for: (A) the first sampling following impoundment; and (B) the peak mercury concentration.

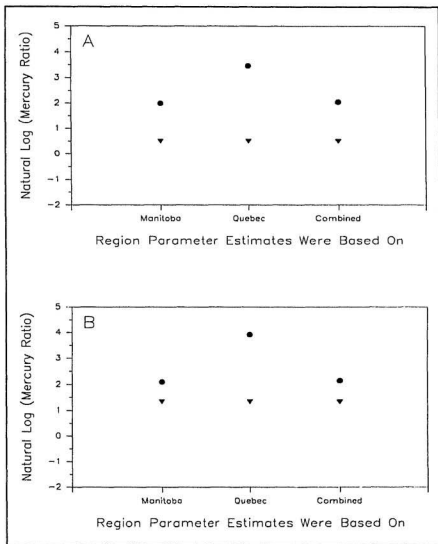

Figure 34 Predicted (●) and observed (▼) values of the natural log of the mercury ratio for brook trout in Cat Arm using Model II for: (A) first sampling following impoundment; and (B) peak mercury concentration.

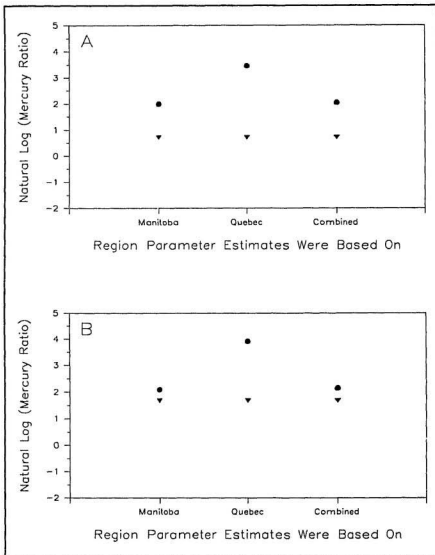

Figure 35 Predicted (•) and observed (▼) values of the natural log of the mercury ratio for Arctic char in Cat Arm using Model II for: (A) first sampling following impoundment; and (B) peak mercury concentration.

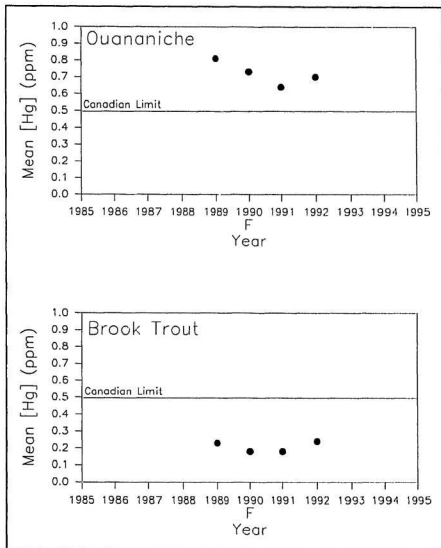

Figure 36 Mean mercury concentrations of ouananiche and brook trout sampled in Long Pond after reimpoundment. The year of reimpoundment (F) and the Canadian consumption guideline of 0.5 ppm mercury are shown.

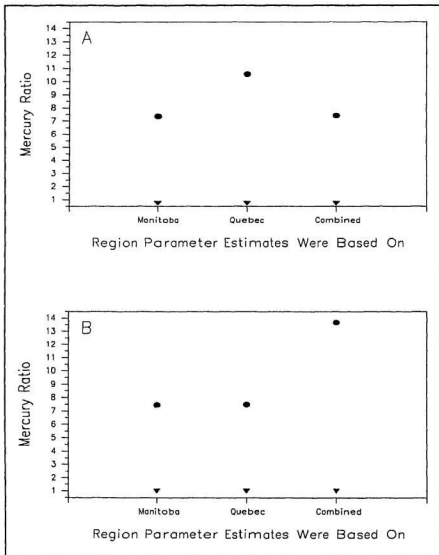

Figure 37 Predicted (●) and observed (▼) values of the mercury ratio for Long Pond brook trout using Model I for: (A) first sampling following reimpoundment; and (B) peak mercury concentration.

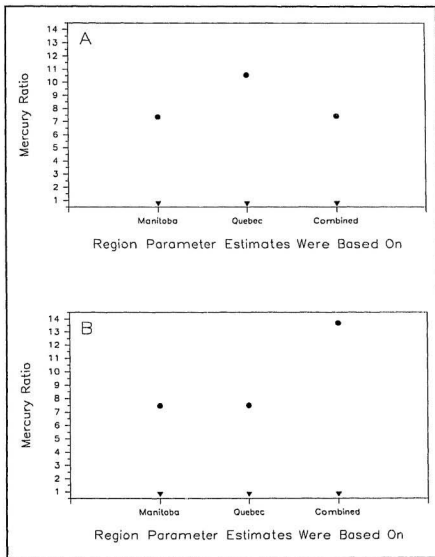

Figure 38 Predicted (•) and observed (▼) values of the mercury ratio for Long Pond ouananiche using Model I for: (A) first sampling following reimpoundment; and (B) peak mercury concentration.

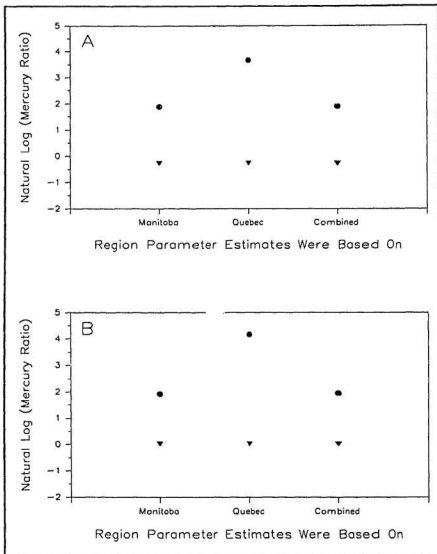

Figure 39 Predicted (•) and observed (▼) values of the natural log of the mercury ratio for Long Pond brook trout using Model II for: (A) first sampling following reimpoundment; and (B) peak mercury concentration.

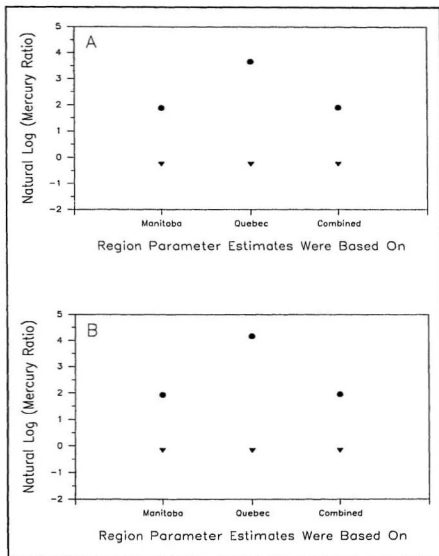

Figure 40 Predicted (•) and observed (▼) values of the natural log of the mercury ratio for Long Pond ouaniche using Model II for: (A) first sampling following reimpoundment; and (B) peak mercury concentration.

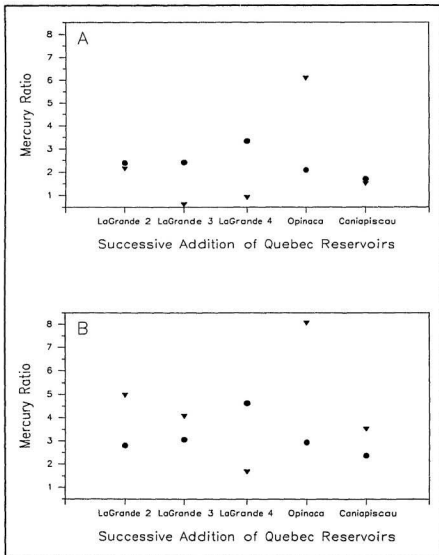

Figure 41 Predicted (•) and observed (▼) values of the mercury ratio for northern pike, for Model III using: (A) the first sampling following impoundment; and (B) the peak mercury concentration.

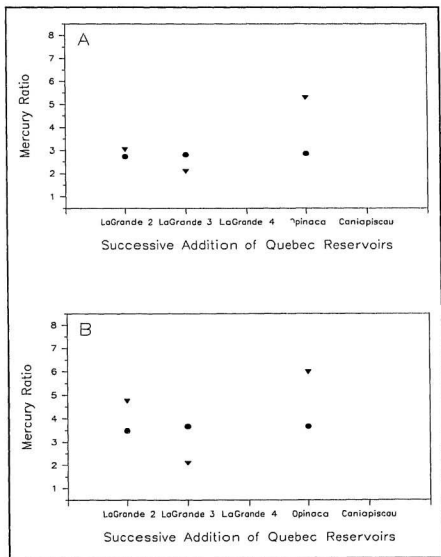

Figure 42 Predicted (●) and observed (▼) values of the mercury ratio for walleye, for Model III using: (A) the first sampling following impoundment; and (B) the peak mercury concentration.

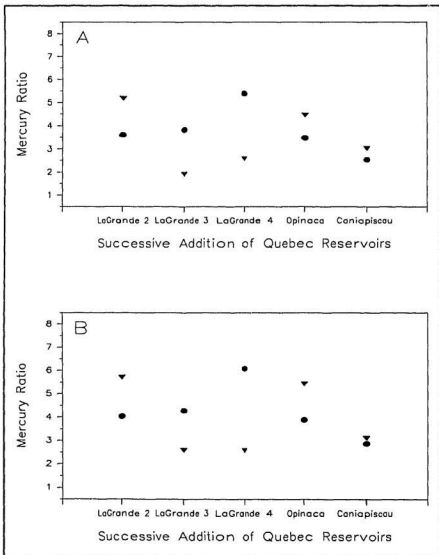

Figure 43 Predicted (•) and observed (▼) values of the mercury ratio for lake whitefish, for Model III using: (A) the first sampling following impoundment; and (B) the peak mercury concentration.

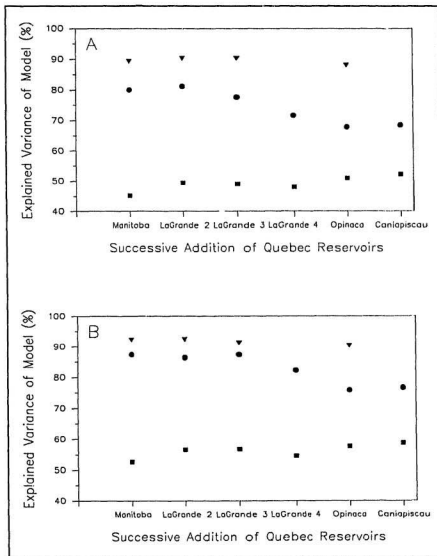

Figure 44 Explained variance of Model III for northern pike (•), walleye (▼), and lake whitefish (■) plotted by reservoir using: (A) the first sampling following impoundment; and (B) the peak mercury concentration.

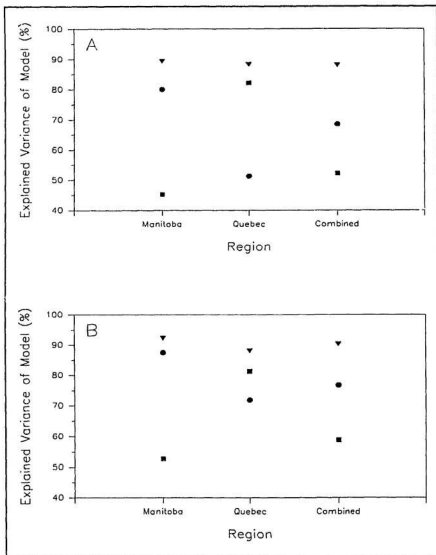

Figure 45 Explained variance of Model III for northern pike (●), walleye (▼), and lake whitefish (■) by region and when combined for: (A) the first sampling following impoundment; and (B) the peak mercury concentration.

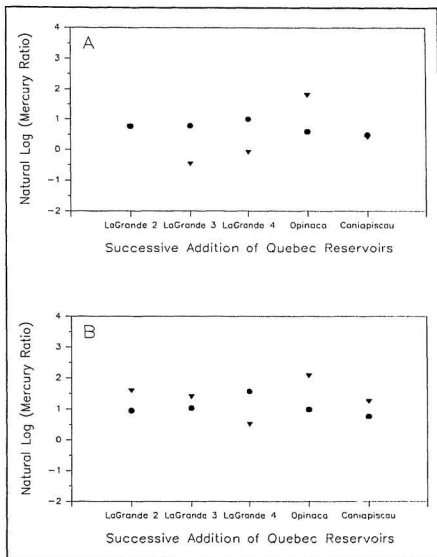

Figure 46 Predicted (•) and observed (▼) values of the natural logarithm of the mercury ratio for northern pike, for Model IV using: (A) the first sampling period following impoundment; and (B) the peak mercury concentration.

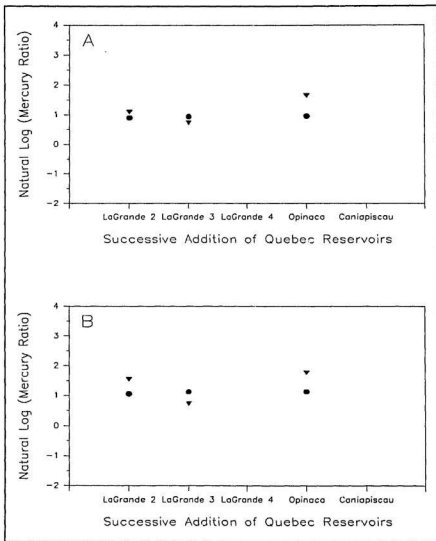

Figure 47 Predicted (●) and observed (▼) values of the natural logarithm of the mercury ratio for walleye, for Model IV using: (A) the first sampling period following impoundment; and (B) the peak mercury concentrations.

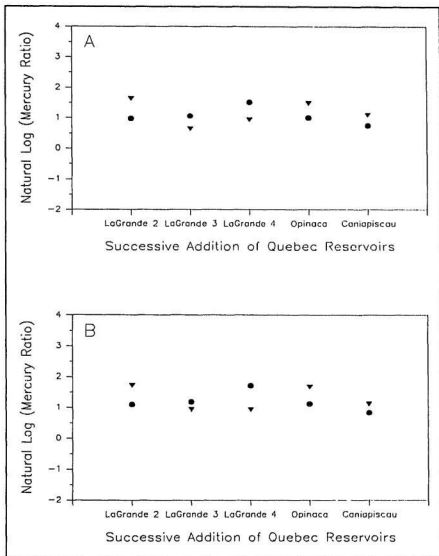

Figure 48 Predicted (●) and observed (▼) values of the natural logarithm of the mercury ratio for lake whitefish, for Model IV using: (A) the first sampling period following impoundment; and (B) the peak mercury concentrations.

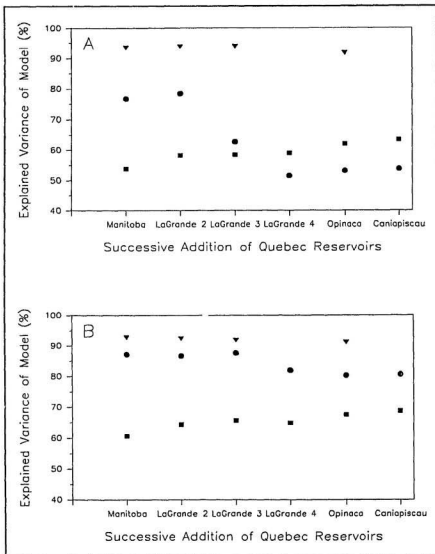

Figure 49 Explained variance of Model IV for northern pike (●), walleye (▼), and lake whitefish (■), by reservoir for: (A) the first sampling period following impoundment; and (B) the peak mercury concentrations.

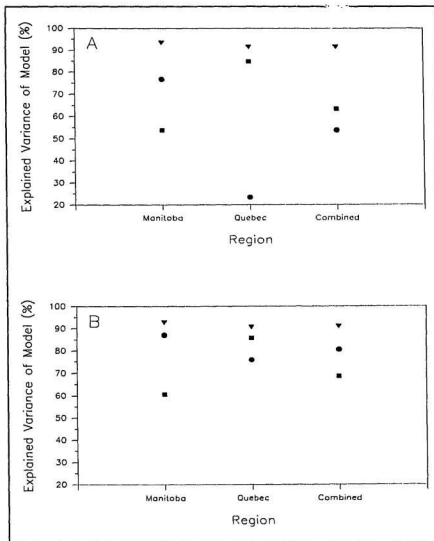

Figure 50 Explained variance of Model IV for northern pike (●), walleye (▼), and lake whitefish (■), for each region and when combined for: (A) the first sampling following impoundment; and (B) the peak mercury concentrations.

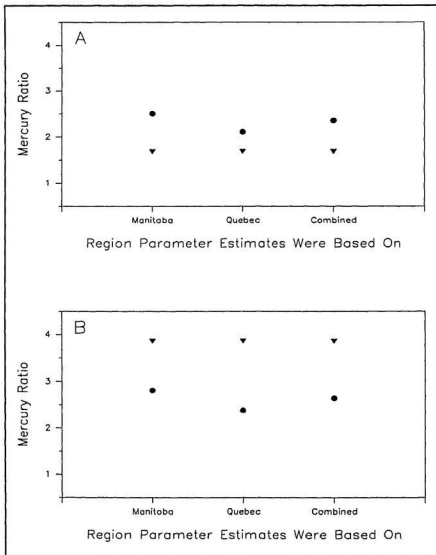

Figure 51 Predicted (●) and observed (▼) values of the mercury ratio for brook trout in Cat Arm Reservoir using Model III for: (A) the first sampling following impoundment; and (B) the peak mercury concentration.

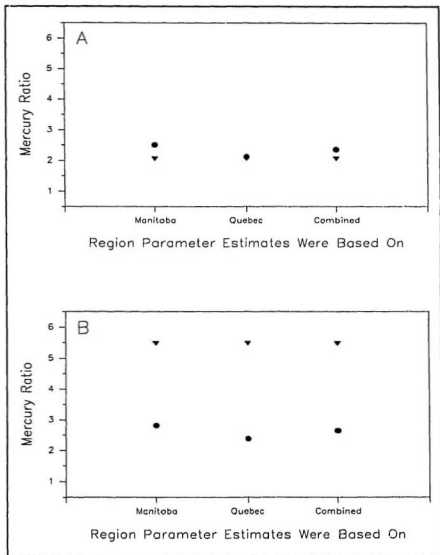

Figure S2 Predicted (●) and observed (▼) values of the mercury ratio for Arctic char in Cat Arm Reservoir using Model III for: (A) the first sampling following impoundment; and (B) the peak mercury concentration.

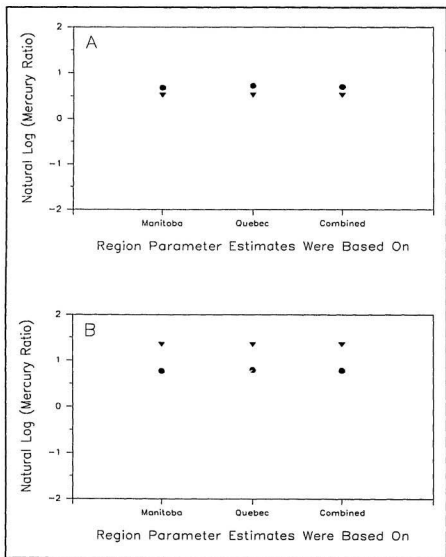

Figure 53 Predicted (●) and observed (▼) values of the natural log of the mercury ratio for brook trout in Cat Arm using Model IV for: (A) first sampling following impoundment; and (B) peak mercury concentration.

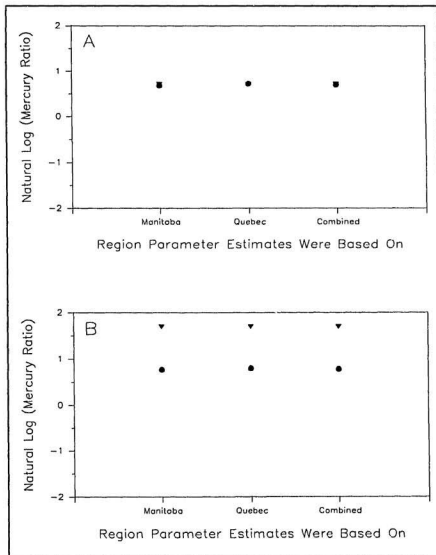

Figure 54 Predicted (•) and observed (◴) values of the natural log of the mercury ratio for Arctic char in Cat Arm using Model IV for: (A) first sampling following impoundment; and (B) peak mercury concentration.

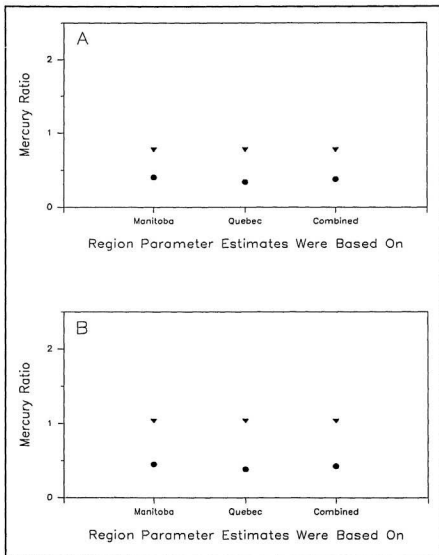

Figure 55 Predicted (•) and observed (▼) values of the mercury ratio for Long Pond brook trout using Model III for: (A) first sampling following reimpoundment; and (B) peak mercury concentration.

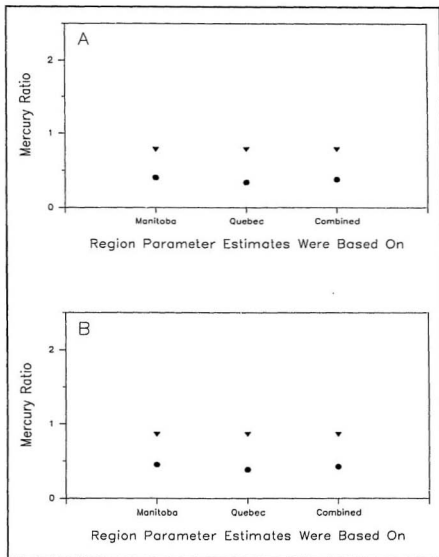

Figure 56 Predicted (●) and observed (▼) values of the mercury ratio for Long Pond ouananiche using Model III for: (A) first sampling following reimpoundment; and (B) peak mercury concentration.

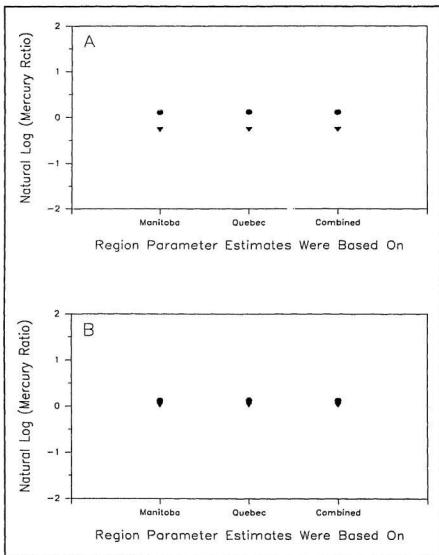

Figure 57 Predicted (•) and observed (▼) values of the natural log of the mercury ratio for Long Pond brook trout using Model IV for: (A) first sampling following reimpoundment; and (B) peak mercury concentration.

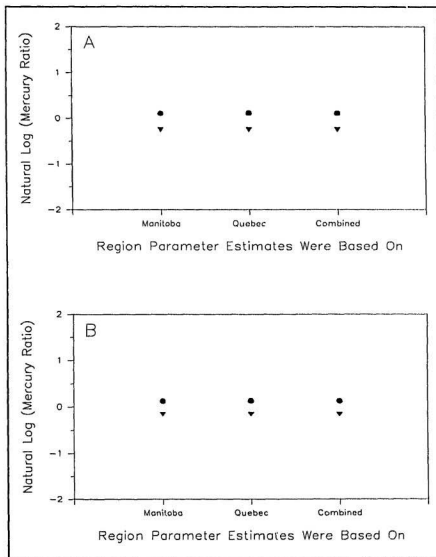

Figure 58 Predicted (●) and observed (▼) values of the natural log of the mercury ratio for Long Pond ouananiche using Model IV for: (A) first sampling following reimpoundment; and (B) peak mercury concentration.

8.0 DISCUSSION

8.1 Model I, II, III, and IV (Equations 12, 13, 50, 51)

8.1.1 Model I

Model I performed well for both the first sampling period following impoundment and peak mercury concentrations for northern pike (Figure 22), walleye (Figure 23), and lake whitefish (Figure 24). For two of the three species, the skill increased with the last Quebec reservoir since a model based on four Quebec reservoirs plus the Manitoba reservoirs was good at predicting the mercury ratio for both northern pike and lake whitefish in Caniapiscou Reservoir. For walleye, Opinaca Reservoir was the last Quebec reservoir to be predicted and the skill of Model I decreased. It was interesting that both of the piscivorous species (northern pike and walleye) showed a substantial difference between the predicted and observed values for Opinaca Reservoir. This trend was not observed for lake whitefish, a first level carnivore, in Opinaca Reservoir. This cannot be attributed to differing food habits because the skill of this model was good for other Quebec reservoir predictions, for each of the three species.

The explained variance of Model I remained high with increased sample size (Figure 25) and despite change in region (Figure 26) for both the first sampling period following impoundment and peak mercury concentrations. As reservoirs were

added in succession, the explained variance remained constant for walleye and lake whitefish. For northern pike, there was a decrease in explained variance. The explained variance for Manitoba reservoirs, Quebec reservoirs and all the reservoirs combined, was greater than 70% for each of the three species examined.

Model I did not accurately predict the mercury ratio for salmonids (brook trout and Arctic char) in Cat Arm Reservoir. For both the first sampling period following impoundment and peak mercury concentrations, the observed mercury ratio for brook trout (Figure 32) and Arctic char (Figure 33) was greatly overpredicted because the dilution term was far more influential than the enrichment term. Predominance of the dilution term was also inconsistent with the findings of Hall *et al.* (1994) who demonstrated the food web was the primary pathway for mercury accumulation by fish.

Model I was similarly unsuccessful at predicting the mercury ratio for brook trout and ouananiche following the reimpoundment of Long Pond Reservoir. This model greatly overpredicted the observed value of the mercury ratio for brook trout (Figure 37) and ouananiche (Figure 38). Parameter estimates for lake whitefish were used to predict brook trout and ouananiche but it was unlikely that this alone caused such a difference between the predicted and observed values. It is more likely that the problem of an inaccurate dilution term worsened for Long Pond due to the very small change in area associated with its reimpoundment.

8.1.2 Model II

Model II performed well for northern pike (Figure 27), walleye (Figure 28), and lake whitefish (Figure 29), for both the first sampling period following impoundment and peak mercury concentrations. The predicted and observed values of the natural logarithm of the mercury ratio were close for each of the three species. The largest differences between the predicted and observed values occurred for the piscivorous northern pike. It appeared Model II worked better for walleye and lake whitefish than for northern pike.

The explained variance for Model II was generally high when applied for increasing sample size (Figure 30) and across two regions (Figure 31) for both the first sampling period following impoundment and peak mercury concentrations. Explained variances tended to be greater than 85% for each of the three species. However, there were definite trends among species. As reservoirs were added in succession, the explained variance for northern pike decreased. One possible explanation for this is the low explained variance observed for northern pike in Quebec reservoirs.

Model II failed to predict the natural logarithm of the mercury ratio for either brook trout or Arctic char in Cat Arm Reservoir, when applied to either the first sampling period following impoundment or peak mercury concentrations. For peak mercury concentrations, this model was good at predicting the natural logarithm of the mercury ratio for brook trout (Figure 34) and Arctic char (Figure 35). But, when

applied to the first sampling period following impoundment, there was a far greater difference between the predicted and observed values. One possible explanation for the failure of this model is species differences. However, it is more likely that this difference was a result of an overly influential dilution term.

Model II failed to predict the natural logarithm of the mercury ratio for brook trout or ouananiche in Long Pond Reservoir following reimpoundment. For both the first sampling period following reimpoundment and peak mercury concentrations, the natural logarithm of the mercury ratio was greatly overpredicted for brook trout (Figure 39) and ouananiche (Figure 40). One explanation for the difference between predicted and observed values is species differences. However, the difference between predicted and observed values is more likely due to an inaccurate model.

8.1.3 Model III

Model III, a revision of Model I, performed as well as Model I for northern pike (Figure 41), walleye (Figure 42), and lake whitefish (Figure 43), for both the first sampling period following impoundment and peak mercury concentrations. The difference between the predicted and observed values was small, except for northern pike and walleye in one reservoir, Opinaca. The skill of this model increased for northern pike and lake whitefish but decreased for walleye. One explanation for the different trends in skill is the difference in the number of reservoirs with each species. Northern pike and walleye were present in all five Quebec reservoirs while

walleye were only present in three.

Trends in explained variance for Model III for both the first sampling period following impoundment and peak mercury concentrations depended on species both within (Figure 44) and among (Figure 45) regions. The explained variance was high for northern pike and walleye but not for lake whitefish. One explanation is regional differences in lake whitefish populations. The explained variance was low for Manitoba lake whitefish but high for Quebec lake whitefish. When the two regions were combined, the overall explained variance was reduced.

Model III, unlike Models I and II, predicted the mercury ratio for Cat Arm brook trout (Figure 51) and Arctic char (Figure 52) for both the first sampling period following impoundment and peak mercury concentrations. It was interesting that Model III consistently predicted too low a ratio for peak mercury concentrations. One explanation may be differences in the evolution of mercury regimes in Cat Arm compared to the mainland reservoirs. Lake whitefish mercury levels rose rapidly following impoundment in Manitoba and Quebec but brook trout and Arctic char in Cat Arm took several years to reach peak mercury concentrations. Small fish size and low growth rates in Newfoundland fish suggest that limited food intake may occur, which could reduce mercury accumulation.

Model III was also good at predicting the mercury ratio for brook trout (Figure 55) and ouananiche (Figure 56) in Long Pond Reservoir for both the first sampling period following reimpoundment and peak mercury concentrations. For

both species the predicted values were close to the observed values of the mercury ratio. The predicted lack of change in the mercury concentration of brook trout and ouananiche in Long Pond following reimpoundment was confirmed by the observed lack of change.

8.1.4 Model IV

Model IV, a revision of Model II, performed as well as Model II for northern pike (Figure 46), walleye (Figure 47), and lake whitefish (Figure 48), for both the first sampling period following impoundment and peak mercury concentrations. The skill of this model was better for walleye and lake whitefish than for northern pike.

Trends in explained variance for Model IV when applied to both the first sampling period following impoundment and peak mercury concentrations depended on species within (Figure 49) and among (Figure 50) regions. With increasing sample size, the explained variance for walleye was high. For lake whitefish, the explained variance increased. Generally, the explained variance was lower for northern pike. One explanation may be regional differences. The explained variance for northern pike was consistently lower for Quebec reservoirs than for Manitoba reservoirs.

Like Model III, Model IV was successful at predicting the observed value of the natural logarithm of the mercury ratio for the two salmonids inhabiting Cat Arm Reservoir. When applied to the first sampling period following impoundment, the

predicted and observed values were very close for brook trout (Figure 53) and almost identical for Arctic char (Figure 54). When Model IV was applied to peak mercury concentrations, the predicted and observed values of the natural logarithm of the mercury ratio were close for both species.

Model IV also performed well when applied to the Long Pond reimpoundment prediction. The predicted and observed values of the natural logarithm of the mercury ratio were close for brook trout (Figure 57) and ouananiche (Figure 58) for both the first sampling period following reimpoundment and peak mercury concentrations. Once again, the predicted lack of change in the mercury concentration of brook trout or ouananiche was confirmed by the observed values.

8.1.5 Comparison of the Four Models

The four models performed well when Quebec reservoirs were added in succession to predict the mercury ratio, or natural logarithm of the mercury ratio, for the next Quebec reservoir. However, when these models were applied to reservoirs not used in their development it was evident that Model I (equation 12) and Model II (equation 13) did not adequately predict the mercury ratio for fish in Cat Arm or Long Pond. For both models, an overprediction resulted from an overly influential dilution term. There was no reason for the dilution term to play a more significant role than the enrichment term in these models. Recent experimental work (e.g. Hall *et al.*, 1994) suggests that the enrichment term should be influential due to the

increased organic matter from flooded soils (e.g. Heyes *et al.*, 1994). The two models in which the dilution term was omitted (Model III and Model IV) were able to predict accurately the mercury ratio and natural logarithm of the mercury ratio for salmonids in both Cat Arm Reservoir (following impoundment) and Long Pond Reservoir (following reimpoundment). It is unlikely that Models I or II could successfully predict changes in the mercury ratio for small changes in reservoir size in either Manitoba or Quebec.

The failure of Models I and II to predict the mercury ratio for Newfoundland salmonids did not result from using parameter estimates derived for a different species. In a few isolated cases, when parameter estimates derived for lake whitefish for Model I and II were used, the predicted and observed values of either the mercury ratio or the natural logarithm of the mercury ratio were close. However, the accuracy with which Model III and Model IV predicted the mercury ratio or natural logarithm of the mercury ratio does indicate that lake whitefish parameter estimates could be used to predict species with a comparable trophic level. The parameter estimates derived for northern pike and walleye should also be applicable to fish species of similarly high trophic levels.

8.2 Sources for Improvement

A large number of variables can influence fish mercury concentrations either directly (e.g. controlling the rate of bioaccumulation) or indirectly (e.g. controlling the rates of availability through methylation and demethylation). Under natural conditions, the uptake of mercury by fish is highly variable (Cope *et al.*, 1990; Mierle and Ingram, 1991; Wren and MacCrimmon, 1986) leading to both intra- and inter-lake variability. Fish size could be used potentially as a source of improvement for these models. Some studies have found a positive correlation between fish size and fish mercury concentration (e.g. Phillips *et al.*, 1980; Scott and Armstrong, 1972; Jernelöv and Lann, 1971). The size data presented herein for brook trout and Arctic char from Cat Arm Reservoir indicated that the relation of fish mercury concentration to fork length or weight was highly irregular (Figures 18 – 21). In some cases there were positive correlations between fish mercury concentrations and size (either fork length or weight) and hence including this relation may prove useful.

For each of the four models, some improvement in precision of measurement is possible. This includes the preimpoundment surface area of lakes to be flooded, the postimpoundment surface area of the newly impounded reservoir, and the mercury concentration of fish both prior to and after impoundment. Of these variables, the one least precise is the mercury concentration in preimpoundment fish. For most reservoirs flooded as part of the Southern Indian Lake/Churchill River Diversion

Project in northern Manitoba and some reservoirs impounded as part of the La Grande Complex in northern Quebec, there were no measurements of preimpoundment mercury concentrations. In these cases it was necessary to use mercury concentrations from fish in control lakes in either northern Manitoba or northern Quebec. Control lakes used in all analyses were: a) remote from anthropogenic (i.e. kraft effluent) or natural mercury inputs (i.e. mercury faults); b) located within the same geographical region as the reservoirs; and c) not connected, either directly or indirectly, to an existing reservoir. However, differences may exist between mercury concentration in fish from control lakes and the "true" preimpoundment mercury concentrations for fish inhabiting lakes, which were later impounded.

Accounting for the type of soil flooded during impoundment may also improve the models. This study focused largely on three definable regions: 1) Manitoba and the Southern Indian Lake/Churchill River Diversion Project; 2) Quebec and the La Grande Complex; and 3) Newfoundland and Cat Arm Reservoir and Long Pond Reservoir. Of these three regions, Newfoundland differs the most from the other two. Recently, Heyes *et al.* (1994) showed that flooded peat contains many sites for microbial methylation of mercury resulting in increased methylmercury production and subsequent biomagnification of this substance through the food chain. Future models may thus consider including the volume of mercury generated through the type of soil flooded during impoundment. That is, fish from a reservoir where 75%

of the flooded area was peat would be expected to show higher mercury concentrations than from a reservoir with peat forming only 30% of the flooded area.

Water color, which is related to the type of soil, is another potential area for improvement of the models. Previous studies have associated water mercury concentrations with water color (Mierle and Ingram, 1991). Measures of organic content have been linked to fish mercury concentrations in natural lakes (McMurtry *et al.*, 1989) and reservoirs (Mannio *et al.*, 1986; Verta *et al.*, 1986). Inorganic mercury is strongly adsorbed onto organic and inorganic particulates (Beneš and Havlik, 1979; Rudd *et al.*, 1980b) and Rask and Metsälä (1991) found higher mercury concentrations in northern pike from humic water than from uncolored water.

Water residence time for reservoirs may be considered in future models as it affects the biological production of methylmercury, its export rate, and the duration of filling which in turn influences the quantity of organic matter available over time (Verdon *et al.*, 1991). If water is rapidly turned over, the organic material and nutrients are rapidly flushed, depriving the bacterial communities of food required for mercury methylation. However, water residence time is often difficult to measure because reservoirs behave differently than natural lakes. Reservoirs tend to have large areas of dead space where water is not mixed or circulated. Reservoirs also tend to be drawn down in the fall and flooded in the spring. This may serve to stimulate methylmercury production.

Often reservoirs are impounded in series and not as a single, isolated system. Future models may address the flow dynamics of a reservoir complex and the order of impoundment. The La Grande Complex in northern Quebec currently consists of five reservoirs. The first to be impounded (La Grande 2) was the last in a chain and the last reservoir impounded (Caniapiscou) was the furthest upstream. Thus, the initial increase in methylmercury production due to nutrient and microbial fluxes following impoundment was re-initiated several times within this complex. The outflow of a new reservoir is likely to be rich in organic matter, thereby providing a new surge of microbial substrate and nutrients to downstream locations. This flux may result in secondary periods of methylmercury production for older reservoirs. The Southern Indian Lake/Churchill River Diversion Project was impounded in a different manner. The first reservoir to be impounded (Southern Indian Lake) was the furthest upstream and the last reservoir was the furthest downstream. In addition, most of the reservoirs in this project were impounded at nearly the same time while those in the La Grande Complex were impounded over a period of several years. In Manitoba it is less likely that reservoirs downstream of the initial impoundment would experience additional fluxes of organic material other than those expected within the first three years. Future models may also address behaviour differences between single reservoir systems such as Cat Arm and multi-reservoir complexes such as the La Grande Complex or the Southern Indian Lake/Churchill River Diversion Project.

8.3 Applications

Previous work on modelling fish mercury concentrations following reservoir impoundment has focused on the use of empirical models (e.g. Bodaly *et al.*, 1984a; Johnston *et al.*, 1991). The empirical model of Jones *et al.* (1986) indicated that the extent of flooding was not a useful predictor variable by itself. The research reported here showed that the extent of flooding can be a very useful predictive variable. Models III and IV, based upon the extent of flooding, were able to accurately predict the change in fish mercury concentrations for different species. When applied to reservoirs not used to develop the models, Models III and IV were skilful at predicting the change in mercury concentrations due to both a large change in area such as Cat Arm (i.e. the impoundment of a lake) and a small change in area such as Long Pond (i.e. altering the size of an existing reservoir). This thesis also showed that if trophic level is comparable, parameter estimates derived for one species could successfully be applied to another.

LITERATURE CITED

- Abernathy, A. R., and P. M. Cumbie. 1977. Mercury accumulation by largemouth bass (*Micropterus salmoides*) in recently impounded reservoirs. Bull. Environm. Contam. Toxicol. 17 (5): 595-602.
- Ahrland, S. 1966. Reports on hard and soft acids and bases -- Factors contributing to (b) behaviour in acceptors. Struct. Bonding 1: 207-220.
- Akielazek, J. J., and T. A. Haines. 1981. Mercury in the muscle tissue of fish from three northern Maine lakes. Bull. Environ. Contam. Toxicol. 27: 201-208.
- Alftan, G., O. Järvinen, J. Pikkatainen, and M. Verta. 1983. Mercury and artificial lakes in Northern Finland possible ecological and health consequences. Nordic Council Arct. Med. Res. Rep. No. 35: 77-81.
- Amend, D. F., W. T. Yasutake, and R. Morgan. 1969. Some factors influencing susceptibility of rainbow trout to the acute toxicity of ethyl mercury phosphate formulation (Timsan). Trans. Am. Fish. Soc. 98: 419-425.

- Amend, D. F. 1970. Retention of mercury by salmon. *Prog. Fish Cult.* 32(4): 192-194.
- Anon. 1973. Final report. Task force on organic mercury in the environment. Grassy Narrows and White Dog, Ontario. Health and Welfare Canada. 20+5+20 p.
- Armstrong, F. A. J., and J. F. Uth . 1971. Semi-automated determination of mercury in animal tissue. *Atomic Absorption Newsletter* 10: 101.
- Armstrong, F. A. J., and A. L. Hamilton. 1973. Pathways of mercury in a polluted northwestern Ontario Lake, p. 133-156. *In* P. C. Sanger [ed.] Trace metal and organic interaction in natural water. Ann Arbor Science Publishers, Ann Arbor, MI.
- Armstrong, F. A. J., and D. P. Scott. 1979. Decrease in mercury content of fishes in Ball Lake, Ontario, since imposition of controls on mercury discharges. *J. Fish. Res. Bd. Canada* 36: 670-672.
- Bache, C. A., W. H. Gutenmann, and D. J. Lisk. 1971. Residues of total mercury and methyl mercury in lake trout as a function of age. *Science (Wash, D.C.)* 172: 951.

- Backstrom, J. 1969. Distribution studies of mercuric pesticides in quail and some freshwater fishes. *Acta Pharmacol. Toxicol.* 27: 1-103.
- Baker, M. D., W. E. Inniss, C. I. Mayfield, P. T. S. Wong, and Y. K. Chau. 1983. Effect of pH on the methylation of mercury and arsenic by sediment microorganisms. *Environ. Tech. Lett.* 4: 89-100.
- Beak Consultants Ltd. 1980a. Cat Arm hydroelectric project environmental impact assessment fisheries resource study. Prepared for Newfoundland and Labrador Hydro, St. John's, Newfoundland. 82 p.
- Beak Consultants Ltd. 1980b. Cat Arm hydroelectric project environmental impact assessment fisheries resource study addendum: Anadromous trout study. Prepared for Newfoundland and Labrador Hydro, St. John's, Newfoundland. 36 p.
- Beckman, L. G., and J. H. Elrod. 1971. Apparent abundance and distribution of young-of-year fishes in Lake Oahe, 1965-69, p. 333-347. *In* G. E. Hall [ed.] Reservoir fisheries and limnology. *Am. Fish. Soc. Spec. Publ.* No. 8.

- Beijer, K., and A. Jernelöv. 1979. Methylation of mercury in aquatic environments, p. 203-210. *In* J. O. Nriagu [ed.] *The biogeochemistry of mercury in the environment*. Elsevier/North Holland Biomedical Press, Amsterdam, The Netherlands.
- Beneš, P., E. T. Gjessing, and E. Steinnes. 1976. Interactions between humus and trace elements in fresh water. *Water Res.* 10: 711-716.
- Beneš, P., and B. Havlik. 1979. Speciation of mercury in natural waters. *In*: J. O. Nriagu, [ed.], *The biogeochemistry of mercury in the environment*. Elsevier/North-Holland Biomedical Press, New York, NY, pp. 175-202.
- Berglund, F., M. Berlin, G. Birke, R. Cedarlof, U. von Euler, L. Friberg, B. Holmstedt, E. Jonsson, K. G. Luning, C. Ramel, S. Skerfving, A. Sensson, and S. Tejning. 1971. Methylmercury in fish, a toxicologic-epidemiological evaluation of risks. Report from an Expert Group. *Nordisk Hygienisk Tidskrift (Suppl. 4)*.
- Billen, G., C. Joiris, and R. Wollast. 1974. A bacterial methylmercury-mineralizing activity in river sediments. *Wat. Res.* 8: 219-225.

- Bishop, J. N., and B. P. Neary. 1976. Mercury levels in fish from northwestern Ontario, 1970-1975. Technical report, Laboratory Services Branch, Ontario Ministry of the Environment, Toronto, Ont.
- Bisogni, J. J. Jr. 1979. Kinetics of methyl mercury formation and decomposition in aquatic environments. p. 211-230. *In* The Biogeochemistry of Mercury in the Environment [ed.] J. O. Nriagu. Elsevier/North Holland, Amsterdam.
- Bisogni, J.J. Jr., and A. W. Lawrence. 1975. Kinetics of mercury methylation in aerobic and anaerobic aquatic environments. *Journal WPCF* 47 (1): 135-152.
- Björklund, I. 1982. Beskrivning av regionala genomsnitthalter av kvicksilver hos gädda inom Sverige. (On the regional mean concentrations of mercury in pike in Sweden.) Statens Naturvårds Verk. 1982-06-24. Mimeographed Report: 20 p.
- Björklund, I., H. Borg, and K. Johansson. 1984. Mercury in Swedish lakes -- its regional distribution and causes. *Ambio* 13 (2): 118-121.
- Björnberg, A., L. Håkanson, and K. Lundbergh. 1988. A theory on the mechanisms regulating the bioavailability of mercury in natural waters. *Environ. Pollut.* 49: 53-61.

- Blaxter, J. H. S. 1970. Fishes and light, p. 213-320. *In* O. Kinne [ed.] Marine ecology. Wiley-Interscience, London.
- Bligh, E. G. 1970. Mercury and the contamination of freshwater fish. *Fish. Res. Bd. Canada MS Rep.* 1088: 27 p.
- Bloom, N. S. 1992. On the chemical form of mercury in edible fish and marine invertebrate tissue. *Can. J. Fish. Aquat. Sci.* 49: 1010-1017.
- Bloom, N. S., and C. J. Watras. 1989. Observations of methylmercury in precipitation. *Sci. Total Environ.* 87/88: 199-207.
- Bodaly, R. A., and L. F. W. Lesack. 1984. Response of a boreal northern pike (*Esox lucius*) population to lake impoundment: Wupaw Bay, Southern Indian Lake, Manitoba. *Can. J. Fish. Aquat. Sci.* 41: 706-714.
- Bodaly, R. A., R. E. Hecky, and R. J. P. Fudge. 1984a. Increases in fish mercury levels in lakes flooded by the Churchill River diversion, northern Manitoba. *Can. J. Fish. Aquat. Sci.* 41: 682-691.

- Bodaly, R. A., T. W. D. Johnston, R. J. P. Fudge, and J. W. Clayton. 1984b. Collapse of the lake whitefish (*Coregonus clupeaformis*) fishery in Southern Indian Lake, Manitoba, following lake impoundment and river diversion. *Can. J. Fish. Aquat. Sci.* **41**: 692-700.
- Bodaly, R. A., N. E. Strange, and R. J. P. Fudge. 1988. Mercury content of fish in the Southern Indian Lake and Issett Lake reservoirs, northern Manitoba, before and after Churchill River Diversion. *Can. Data Rep. Fish. Aquat. Sci.* **706**: v + 59 p.
- Bodaly, R. A., J. W. M. Rudd, R. J. P. Fudge, and C. A. Kelly. 1993. Mercury concentrations in fish related to size of remote Canadian Shield lakes. *Can. J. Fish. Aquat. Sci.* **50**: 980-987.
- Boëtius, J. 1960. Lethal action of mercuric chloride and phenylmercuric acetate on fishes. *Medd. Dan. Fisk. Havunders.* **3**: 93-115.
- Boucher, R., R. Schetagne, and E. Magnin. 1985. Teneur en mercure des poissons des réservoirs La Grande 2 et Opinaca (Québec, Canada) avant et après la mise en eau. *Rev. Fr. Sci. Eau* **4**: 193-206.

- Boudou, A., A. Delarche, F. Ribeyre, and R. Marty. 1979. Bioaccumulation and bioamplification of mercury compounds in a second level consumer, *Gambusia affinis* -- temperature effects. *Bull. Environm. Contam. Toxicol.* **22**: 813-818.
- Branson, D. R., W. B. Neely, and G. E. Blau. 1975. Predicting a bioconcentration potential of organic chemicals in fish from partition coefficients. In: Structure activity correlations in studies of toxicity and bioconcentration with aquatic organisms, pp. 99-117. Proc. Symposium, sponsored by C.C.I.W. at Burlington, Ontario, March 11-13, 1975.
- Brosset, C. 1981. The mercury cycle (preliminary communication). *Water Air Soil Pollut.* **16**: 253-255.
- Brosset, C. 1987. The behaviour of mercury in the physical environment. *Water Air Soil Pollut.* **34**: 145-166.
- Brouard, D., C. Demers, R. Lalumière, R. Schetagne, and R. Verdon. 1989. Summary Report. Evolution of mercury levels in fish of the La Grande hydroelectric complex, Québec (1978-1989). Joint report. Vice-présidence Environnement, Hydro-Québec and Groupe Environnement Shooner inc.: 97p.

Brouzes, R. J., R. A. McLean, and G. H. Tomlinson. 1977. The link between pH of natural waters and the mercury content of fish. Research Report to the U.S. National Academy of Science. Domtar Res. Rep., Senneville, Que.

Bruce, W. J. 1984. Potential fisheries yield from Smallwood Reservoir, western Labrador, with special emphasis on lake whitefish. *N. Am. J. Fish. Manage.* 4: 48-66.

Bruce, W. J., and K. D. Spencer. 1979. Mercury levels in Labrador fish, 1977-78. *Can. Ind. Report of Fish. Aquat. Sci.* No. 111.

Buchanan, R. A. 1990. Monitoring of fish habitat and mercury concentrations in Salmonids at the Long Pond Reservoir, Bay d'Espoir, Newfoundland. Unpublished Report by R. A. Buchanan, LGL Limited, PO Box 13248 Stn A, 388 Kenmount Road, St. John's, NF, A1B 4A5.

Buchanan, R. A. 1991. Long Pond Reservoir mercury monitoring program 1990. Unpublished Report by R. A. Buchanan, LGL Limited, PO Box 13248 Stn A, 388 Kenmount Road, St. John's, NF, A1B 4A5.

- Buchanan, R. A. 1993. Long Pond Reservoir mercury monitoring program 1991.
Unpublished Report by R. A. Buchanan, LGL Limited, PO Box 13248 Stn A,
388 Kenmount Road, St. John's, NF, A1B 4A5.
- Buchanan, R. A. 1994. Long Pond Reservoir mercury monitoring program 1992.
Unpublished Report by R. A. Buchanan, LGL Limited, PO Box 13248 Stn A,
388 Kenmount Road, St. John's, NF, A1B 4A5.
- Burkett, R. D. 1974. The influence of temperature on the uptake of methylmercury-
203 by bluntnose minnows, *Pimephales notatus* (Rafinesque). Bull. Environm.
Contam. Toxicol. **12**: 703-709.
- Burrows, W. D., and P. A. Krenkel. 1973. Studies on uptake of methylmercury-203
by bluegills (*Lepomis macrochirus* Raf.). Environ. Sci. Technol. **7** (13):
1127-1130.
- Burrows, W. D., K. I. Taimi, and P. A. Krenkel. 1974. The uptake and loss of
methylmercury by freshwater fish. p. 283-288. In Proceedings Congrese
Internacional del Mercurio, Tomo II. Barcelona, Spain.

- Carley, A., V. A. Sedlak, E. R. Girling, R. E. Hauck, W. F. Barthel, P. E. Pierce, and W. H. Likosky. 1971. Organic mercury identified as the cause of poisoning in humans and dogs. *Science* **172**(3978): 65-67.
- Chamberlain, L. L. 1972. Primary productivity in a new and older California reservoir. *Calif. Fish Game* **58**(4): 254-267.
- Colby, P. J., R. E. McNicol, and R. A. Ryder. 1979. Synopsis of biological data on the walleye *Stizostedion v. vitreum* (Mitchill 1818). FAO Fisheries Synopsis No. 119. Food and Agriculture Organization of the United Nations, Rome, Italy.
- Cooper, J. L. 1971. The northern pike in Fort Peck Reservoir, Montana. *Proc. Mont. Acad. Sci.* **31**: 53-61.
- Cope, W. G., J. G. Wiener, and R. G. Rada. 1990. Mercury accumulation in yellow perch in Wisconsin seepage lakes: relation to lake characteristics. *Environ. Toxicol. Chem.* **9**: 931-940.

- Cox, J. A., H. W. Holm, H. J. Kania, and R. L. Knight. 1975. Methylmercury and total mercury in selected stream biota. *In* D. D. Hemphill [ed.] Trace Substances in Environmental Health, IX, Univ. Mo. Columbia, Mo. June 10-12, p. 151-155.
- Cox, J. A., J. Carnahan, J. DiNunzio, J. McCoy, and J. Meister. 1979. Source of mercury in fish in new impoundments. *Bull. Environm. Contam. Toxicol.* **23**: 779-783.
- Cranston, R. E., and D. E. Buckley. 1972. Mercury pathways in a river estuary. *Environ. Sci. Technol.* **6**: 274-278.
- deFreitas, A. S. W., S. U. Qadri, and B. E. Case. 1974. Origins and fate of mercury compounds in fish, p. 31-36. *In* Proc. Int. Conf. on Transport of Persistent Chemicals in Aquatic Ecosystems (1-3 May, 1974, Ottawa, Canada). Section III.

deFreitas, A. S. W., Q. N. LaHam, M. A. J. Gidney, B. A. MacKenzie, J. G.

Trepanier, D. Rodgers, M. A. Sharpe, S. Qadri, A. E. McKinnon, P. Clay, and E. Javorski. 1977. Mercury uptake and retention by fish. *In* Distribution and transport of pollutants in flowing water ecosystems. Ottawa River Project. Final Report. Vol. 2: 30.0-30.61

DeSimone, R. E. M., W. Penley, L. Charbonneau, S. G. Smith, J. W. Wood, H. A. O. Hill, J. M. Pratt, S. Risdale, and R. J. P. Williams. 1973. The kinetics and mechanism of cobalamin-dependent methyl and ethyl transfer to mercuric ion. *Biochim. Biophys. Acta* **304**: 851-863.

D'Itri, F. M. 1972. The environmental mercury problem. The Chemical Rubber Co., Cleveland, OH: 124 p.

Domanevskii, L. N. 1957. Some features of the biology of pike of the Tsimlyanskii Reservoir, p. 443-447. *In* A. N. Akatora and B. K. Shtegman [ed.] Trans. 6th Conf. Biol. Inland Waters. (Transl. from Russian by Israel Program for Sci. Transl., Jerusalem, 1969).

- Drinkwater, K. F., and R. A. Myers. 1987. Testing predictions of marine fish and shellfish landings from environmental variables. *Can. J. Fish. Aquat. Sci.* **44**: 1568-1573.
- Driscoll, C. T., C. Yan, C. L. Schofield, R. Munson, and J. Holsapple. 1994. The mercury cycle and fish in the Adirondack lakes. *Environ. Sci. Technol.* **28**(3): 136A-143A.
- Driscoll, C. T., V. Blette, C. Yan, C. L. Schofield, R. Munson, and J. Holsapple. 1995. The role of dissolved organic carbon in the chemistry and bioavailability of mercury in remote Adirondack lakes. *Water Air Soil Pollut.* **80**: 499-508.
- Duthie, H. C., and M. L. Ostrofsky. 1975. Environmental impact of the Churchill Falls (Labrador) hydroelectric project: a preliminary assessment. *J. Fish. Res. Bd. Canada* **32**: 117-125.
- Ellis, M. M. 1936. Some fisheries problems in impounded waters. *Trans. Am. Fish. Soc.* **66**: 63-75.

- Fagerström, T., and B. Åsell. 1973. Methylmercury accumulation in an aquatic food chain: a model and some implications for research planning. *Ambio* 2 (5): 164-171.
- Fang, S. C. 1973. Uptake and biotransformation of phenylmercuric acetate by aquatic organisms. *Arch. Environ. Contam. Toxicol.* 1: 18-26.
- Fitzgerald, W. F., and T. W. Clarkson. 1991. Mercury and monomethylmercury: present and future concerns. *Environ. Health Perspect.* 96: 159-166.
- Fitzgerald, W. F., R. P. Mason, and G. M. Vandal. 1991. Atmospheric cycling and air-water exchange of mercury over mid-continental lacustrine regions. *Water Air Soil Pollut.* 56: 745-767.
- Forrester, C. R., K. Ketchem, and C. C. Wong. 1972. Mercury content of spiny dogfish in the Strait of Georgia, British Columbia. *J. Fish. Res. Bd. Canada* 29: 1487-1490.
- Friberg, L., and J. Vostal. 1972. Mercury in the environment. An epidemiological and toxicological appraisal. CRC Press, Cleveland. 214 p.

- Funk, W. H., and A. R. Gaufin. 1971. Phytoplankton productivity in a Wyoming cooling-water reservoir, p. 167-178. *In* G. E. Hall [ed.] Reservoir fisheries and limnology. Am. Fish. Soc. Spec. Publ. No. 8. Washington D.C.
- Furutani, A., and J. W. M. Rudd. 1980. Measurement of mercury methylation in lake water and sediment samples. *Appl. Environ. Microbiol.* 40 (4): 770-776.
- Furutani, A., J. W. M. Rudd, and C. A. Kelly. 1984. A method for measuring the response of sediment microbial communities to environmental perturbations. *Can. J. Microbiol.* 30: 1408-1414.
- Gardner, W., *et al.* 1975. Concentrations of total mercury and methylmercury in fish and other coastal organisms: implications to mercury cycling. Mineral Cycling in Southeastern Ecosystems, NTIS-CONF-74513.
- Gasaway, C. R. 1970. Changes in the fish population in Lake Francis Case in South Dakota in the first 16 years of impoundment. U.S. Bur. Sport Fish. Wildl. Tech. Pap. 56: 30 p.
- Gavis, J., and J. F. Ferguson. 1972. The cycling of mercury through the environment. *Water Res.* 6: 989-1008.

- Gibbs, R. J. 1973. Mechanisms of trace metal transport in rivers. *Science* (Washington, D.C.) **180**: 71-73.
- Giblin, F. J., and E. J. Massaro. 1972. Pharmacodynamics of methyl mercury in the rainbow trout (*Salmo gairdneri*): tissue uptake, distribution and excretion. *Toxicol. Appl. Pharmacol.* **24**: 81-91.
- Gillespie, D. C., and D. P. Scott. 1971. Mobilization of mercuric sulfide from sediment into fish under aerobic conditions. *J. Fish. Res. Bd. Canada* **28**: 1807-1808.
- Gilmour, C. C., and E. A. Henry. 1991. Mercury methylation in aquatic systems affected by acid deposition. *Environ. Pollut.* **71**: 131-169.
- Glooschenko, W. A. 1969. Accumulation of ^{203}Hg by the marine diatom *Chaetoceros costatum*. *J. Phycol.* **5**: 224-226.
- Grieb, T. M., C. T. Driscoll, S. P. Gloss, C. L. Schofield, G. L. Bowie, and D. B. Porcella. 1990. Factors affecting mercury accumulation in fish in the Upper Michigan Peninsula. *Environ. Toxicol. Chem.* **9**: 919-930.

- Grimard, Y., and H. G. Jones. 1981. Trophic upsurge in new reservoirs: a model for total phosphorus concentration. *Can. J. Fish. Aquat. Sci.* **39**: 1473-1483.
- Grimås, U. 1965. Effects of impoundment on the bottom fauna of high mountain lakes. *Acta Univ. Upsal. Abstr. Uppsala. Diss. Sci.* **51**: 10-11.
- Håkanson, L. 1980. The quantitative impact of pH, bioproduction, and mercury contamination on the Hg content of fish (pike). *Environ. Pollut. (B)* **1**: 285-304.
- Håkanson, L., A. Nilsson, and T. Andersson. 1988. Mercury in fish in Swedish lakes. *Environ. Pollut.* **49**: 145-162.
- Hamdy, M. K., and O. R. Noyes. 1975. Formation of methylmercury by bacteria. *Appl. Microbiol.* **30**: 424-432.
- Hall, B. D., R. A. Bodaly, R. J. P. Fudge, and J. W. M. Rudd. 1994. Food as the dominant pathway of methylmercury uptake by fish. *In* International Conference on Mercury as a Global Pollutant, July 10-14, 1994, Chateau Whistler Resort, Whistler, British Columbia.

- Hannan, P. J., and N. P. Thompson. 1977. Uptake and release of ^{203}Hg by selected soil and sediment samples. *Water Pollut. Control Fed.* **49**: 842-847.
- Hannerz, L. 1968. Experimental investigations on the accumulation of mercury in water organisms. *Rep. Inst. Freshwater Res. Drottningholm* **48**: 120-176.
- Harris, R. C. 1991. A mechanistic model to examine mercury in aquatic systems. M.Sc. Thesis, McMaster University, Hamilton, Ontario: 16+278 pg.
- Harris, R. C., J. W. Rudd, C. A. Kelly, R. A. Bodaly, and W. J. Snodgrass. 1994. Application of a mass-balance mercury model for the 1991-93 pre-flood period at ELA Lake 979 in northwestern Ontario. *In International Conference on Mercury as a Global Pollutant*, July 10-14, 1994, Chateau Whistler Resort, Whistler, British Columbia.
- Hartman, A. M. 1978. Mercury feeding schedules: effects on accumulation, retention, and behaviour in trout. *Trans. Am. Fish. Soc.* **107** (2): 369-375.
- Häsänen, E., and V. Sjöblom. 1968. *Suomen Kalatalous* **36**: 1.

- Hasselrot, T. B. 1968. Report on current field investigations concerning the mercury content in fish, bottom sediment and water. Rep. Inst. Freshwater Res. Drotningholm **48**: 101-111.
- Hasselrot, T. B., and A. Göthberg. 1974. The ways of transport of mercury to fish. *In Proc. Int. Conf. Transp. Persist. Chem. Aquat. Ecosyst. Ottawa, Can. May 1-3, Sect. III, p. 37-47.* "
- Hassler, T. J. 1969. Biology of the northern pike in Oahe Reservoir, 1959 through 1965. U.S. Bur. Sport Fish. Wildl. Tech. Pap. **29**: 3-13.
- Hassler, T. J. 1970. Environmental influences on early development and year class strength of northern pike in Lakes Oahe and Sharpe, South Dakota. *Trans. Am. Fish. Soc.* **99**(2): 369-375.
- Hecky, R. E. 1984. Thermal and optical characteristics of Southern Indian Lake before, during, and after impoundment and Churchill River diversion. *Can. J. Fish. Aquat. Sci.* **41**: 579-590.

- Hecky, R. E., and S. J. Guildford. 1984. Primary productivity of Southern Indian Lake before, during, and after impoundment and Churchill River diversion. *Can. J. Fish. Aquat. Sci.* 41: 591-604.
- Hecky, R. E., R. W. Newbury, R. A. Bodaly, K. Patalas, and D. M. Rosenberg. 1984. Environmental impact prediction and assessment: the Southern Indian Lake experience. *Can. J. Fish. Aquat. Sci.* 41: 720-732.
- Hecky, R. E., R. A. Bodaly, D. J. Ramsey, and N. E. Strange. 1991. Increased methylmercury contamination in fish in newly formed freshwater reservoirs. *In* T. F. W. Clarkson, T. Suzuki, and A. Imura [ed.] *Advances in mercury toxicology*. Plenum Press, New York, NY.
- Helwig, D. D., and S. A. Heiskary. 1985. Fish mercury in N.E. Minnesota lakes, final report. Minnesota Pollution Control Agency, MN.
- Hem, J. D. 1976. Geochemical controls on lead concentrations in steam water and sediments. *Geochim. Cosmochim. Acta* 40: 599-609.
- Henzel, M. R., and D. M. Jamieson. 1976. Determination of mercury in fish. *Anal. Chem.* 48: 926-928.

- Heyes, A., J. W. M. Rudd, T. R. Moore, and N. T. Roulet. 1994. The impact of impoundment on methylmercury concentrations in peat pore water. *In* International Conference on Mercury as a Global Pollutant, July 10-14, 1994, Chateau Whistler Resort, Whistler, British Columbia.
- Hildenbrand, S. G., A. W. Andren, and J. W. Huckabee. 1975. Distribution and bioaccumulation of mercury in biotic and abiotic compartments of a contaminated river reservoir system. Toxicity to Biota of Metal Forms in Natural Waters. Joint Comm. Great Lakes Res. Advis. Bd., Duluth, Minn.
- Holcik, J. 1968. Life history of the pike, *Esox lucius* Linnaeus, 1758, in the Klicava Reservoir. *Vestn. Cesk. Spol. Zool. (Acta Soc. Zool. Bohemoslov.)* 32(2): 166-180.
- Holden, A. V. 1972. Present levels of mercury in man and his environment. p. 142-168. *In* Mercury contamination in man and his environment, Vienna, Int. Atomic Energy Agency.

Huckabee, J. W., R. A. Goldstein, S. A. Janzen, and S. E. Woock. 1975.

Methylmercury in a freshwater foodchain. p. 199-215. *In* Proceedings of the International Conference on Heavy Metals in the Environment, Toronto, Canada (Oct. 27-31, 1975).

Huckabee, J. W., S. A. Janzen, B. G. Blaylock, Y. Talmi, and J. J. Beauchamp.

1978. Methylated mercury in brook trout (*Salvelinus fontinalis*): absence of an in vivo methylating process. *Trans. Am. Fish. Soc.* **107** (6): 848-852.

Huckabee, J. W., J. W. Elwood, and S. G. Hildenbrand. 1979. Accumulation of mercury in freshwater biota, p. 277-301. *In* J. O. Nriagu [ed.] *The biogeochemistry of mercury in the environment*. Elsevier/North Holland Biomedical Press, Amsterdam, The Netherlands.

Hultberg, H., and B. Hasselrot. 1981. Mercury in ecosystem. (Swedish). *K.H.M. information* **04**: 33-55.

Imura, N., S. K. Pan, and T. Ukita. 1972. Methylation of inorganic mercury with liver homogenate of tuna fish. *Chemosphere* **1**: 197-201.

- Iverfeldt, A., and O. Lindqvist. 1986. Atmospheric oxidation of elemental mercury by ozone in the aqueous phase. *Atmos. Environ.* **20**: 1567-1573.
- Jackson, T. A. 1987. Methylation, demethylation, and bio-accumulation of mercury in lakes and reservoirs of northern Manitoba, with particular reference to effects of environmental changes caused by the Churchill-Nelson River diversion. *In* Technical Appendices to the Summary Report, Canada-Manitoba Agreement on the Study and Monitoring of Mercury in the Churchill River Diversion. Vol. 2. Chap. 8. Published by the Governments of Canada and Manitoba.
- Jackson, T. A., G. Kipphut, R. Hesslein, and D. W. Schindler. 1980. Experimental study of trace metal chemistry in soft-water lakes at different pH levels. *Can. J. Fish. Aquat. Sci.* **37**: 387-402.
- Järvenpää, A., M. Tillander, and J. K. Miettinen. 1970. Methyl mercury: half-time of elimination in flounder, pike and eel. *Suomen Kemistilehti* **B43**: 430-442.
- Jensen, S., and A. Jernelöv. 1969. Biological methylation of mercury in aquatic organisms. *Nature (Lond.)* **223**: 753-754.

- Jernelöv, A. 1968. Laboratory experiments on the change of mercury compounds from one into another. *Vatten* **24**: 360-362.
- Jernelöv, A. 1970. Release of methylmercury from sediments with layers containing inorganic mercury at different depths. *Limnol. Oceanogr.* **15**: 958-960.
- Jernelöv, A., and H. Lann. 1971. Mercury accumulation in food chains. *Oikos* **22**: 403-406.
- Jernelöv, A., and H. Lann. 1973. Studies in Sweden on feasibility of some methods for restoration of mercury-contaminated bodies of water. *Environ. Sci. Technol.* **7** (8): 712-718.
- Johnels, A. G., T. Westermark, W. Berg, P. I. Persson, and B. Sjöstrand. 1967. Pike (*Esox lucius* L.) and some other aquatic organisms in Sweden as indicators of mercury contamination in the environment. *Oikos* **18** (2): 323-333.
- Johnston, T. A., R. A. Bodaly, and J. A. Mathias. 1991. Predicting fish mercury levels from physical characteristics of boreal reservoirs. *Can. J. Fish. Aquat. Sci.* **48**: 1468-1475.

- Jones, M. L., G. L. Cunningham, D. R. Marmorek, P. M. Stokes, C. Wren, and D. DeGraff. 1986. Mercury release in hydroelectric reservoirs. Canadian Electrical Association Report No. 185 G 399, Canadian Electrical Association, Research and Development, Montréal, P.Q.: 156 p.
- June, F. C. 1970. Atresia and year-class abundance of northern pike, *Esox lucius*, in two Missouri River impoundments. J. Fish. Res. Bd. Canada 27: 587-591.
- June, F. C. 1971. The reproductive biology of northern pike, *Esox lucius*, in Lake Oahe, an Upper Missouri River storage reservoir, p. 53-71. In G. E. Hall [e...] Reservoir fisheries and limnology. Am. Fish. Soc. Spec. Publ. No. 8.
- Kamps, L. R., R. Carr, and H. Miller. 1972. Total mercury-monomethylmercury content of several species of fish. Bull. Environ. Contam. Toxicol. 8: 273-279.
- Kania, H. J., and J. O'Hara. 1974. Behavioral alterations in a simple predator-prey system due to the sublethal exposure to mercury. Trans. Am. Fish. Soc. 103 (1): 134-135.

- Karickhoff, S. W., and D. S. Brown. 1978. Paraquat sorption as a function of particle size in natural sediments. *J. Environ. Qual.* **7**: 246-252.
- Kleinert, S. J., and P. E. Degurse. 1972. Mercury levels in Wisconsin fish and wildlife. Tech. Bull. No. **52**, Depart. of Nat. Res. Madison, WI, 53701: 22 p.
- Koirtyohann, S. R., R. Meers, and L. K. Graham. 1974. Mercury levels in fishes from some Missouri lakes with and without known mercury pollution. *Environ. Res.* **8**: 1-11.
- Korhonen, P., M. Virtanen, and T. Schultz. 1995. Bioenergetic calculation of mercury accumulation in fish. *Water Air Soil Pollut.* **80**: 901-904.
- Landner, L. 1971. Biochemical model for the biological methylation of mercury suggested from methylation studies *in vivo* with *Neurospora crassa*. *Nature (Lond.)* **230**: 452-453.
- Lasorsa, B., and S. Allen-Gil. 1995. The methylmercury to total mercury ratio in selected marine, freshwater, and terrestrial organisms. *Water Air Soil Pollut.* **80**: 905-913.

- Lathrop, R. C., K. C. Noonan, P. M. Guenther, T. L. Brasino, and P. W. Rasmussen. 1989. Mercury levels in walleyes from Wisconsin lakes of different water and sediment chemistry characteristics. Technical Bulletin No. 163. Wisconsin Department of Natural Resources, Madison, WI.
- Lathrop, R. C., P. W. Rasmussen, and D. R. Knauer. 1991. Mercury concentrations in walleyes from Wisconsin (USA) lakes. *Water Air Soil Pollut.* **56**: 295-307.
- LeDrew, Fudge Associates Limited. 1992. Cat Arm Reservoir monitoring study 1990. Unpublished Report by LeDrew Fudge Associates Limited, 607 Torbay Road, St. John's, Newfoundland, A1A 2Y3.
- Lee, Y. H., and H. Hultberg. 1990. Methylmercury in some Swedish surface waters. *Environ. Toxicol. Chem.* **9**: 833-841.
- Lee, Y. H., H. Hultberg, and I. Andersson. 1985. Catalytic effect of various metal ions on the methylation of mercury in the presence of humic substances. *Water Air Soil Pollut.* **25**: 391-400.
- Lehman, J. T. 1986. The goal of understanding limnology. *Limnol. Oceanogr.* **31**: 1160-1166.

- Leland, H. V., D. J. Wilkes, and E. D. Copenhaver. 1976. Heavy metals and related trace elements. *J. WPCF* **48**(6): 1473
- Lexmond, T. M., F. A. M. Dehaan, and M. J. Frissel. 1976. On the methylation of inorganic mercury and decomposition of organo-mercury compounds -- a review. *Neth. J. Agric. Sci.* **24**: 79-97.
- Lindqvist, O., A. Jernelöv, K. Johansson, and H. Rodhe. 1984. Mercury in the Swedish environment. Global and local sources. Report SNV PM 1816. National Swedish Environment Protection Board, Solna, Sweden.
- Lindqvist, O., and H. Rodhe. 1985. Atmospheric mercury -- a review. *Tellus* **37B**: 136-159.
- Lindström, T. 1973. Life in a lake reservoir: fewer options, decreased production. *Ambio* **2** (5): 145-153.
- Lock, R. A. C. 1975. Uptake of methylmercury by aquatic organisms from water and food. p. 61-79. *In* J. H. Koeman and J. J. T. W. A. Strik [ed.] *Sublethal effects of toxic chemicals on aquatic animals*. Elsevier, Amsterdam-Oxford. New York.

- Lock, R. A. C., and A. P. Van Overbeeke. 1981. Effects of mercuric chloride and methylmercuric chloride on mucus secretion in rainbow trout *Salmo gairdneri* Richardson. *Comp. Biochem. Physiol.* **69C**: 67-73.
- Lockhart, W. L., J. F. Uthe, A. R. Kenney, and P. M. Mehrle. 1972. Methylmercury in northern pike (*Esox lucius*): distribution, elimination, and some biochemical characteristics of contaminated fish. *J. Fish. Res. Bd. Canada* **29**: 1519-1523.
- Lodenus, M. 1991. Mercury concentrations in an aquatic ecosystem during twenty years following abatement the pollution source. *Water Air Soil Pollut.* **56**: 323-332.
- Lodenus, M., A. Seppänen, and M. Herranen. 1983. Accumulation of mercury in fish and man from reservoirs in northern Finland. *Water Air Soil Pollut.* **19**: 237-246.
- Lofroth, G. 1969. Methylmercury. *Rep. Radiobiol. Div., Dep. Biochem., Univ. Stockholm, Work. Group Environ. Toxicol. Ecol. Res. Comm., Swed. Natl. Sci. Res. Counc., Stockholm, Swed.*: 38 p.

- MacLeod, J. C., and E. Pessah. 1973. Temperature effects on mercury accumulation, toxicity, and metabolic rate in rainbow trout (*Salmo gairdneri*). *J. Fish. Res. Bd. Canada* **30**: 485-492.
- Mannio, J., M. Verta, P. Kortelainen, and S. Rekolainen. 1986. The effect of water quality on the mercury concentration of northern pike (*Esox lucius* L.) in Finnish forest lakes and reservoirs. Publications of the Water Research Institute, National Board of Waters, Finland **65**: 32-43.
- Matida, Y., H. Kumada, S. Kimura, Y. Saiga, T. Nose, M. Yokote, and H. Kawatsu. 1971. Toxicity of mercury compounds to aquatic organisms and accumulation of the compounds by the organisms. *Bull. Freshwater Fish Res. Lab. Tokyo* **21**: 197-225.
- McFarlane, G. A., and W. G. Franzin. 1980. An examination of Cd, Cu, and Hg concentrations in livers of northern pike, *Esox lucius*, and white sucker, *Catostomus commersoni*, from five lakes near a base metal smelter at Flin Flon, Manitoba. *Can. J. Fish. Aquat. Sci.* **37**: 1573-1578.
- McKone, C. E., R. G. Young, C. A. Bache, and D. J. Lish. 1971. Rapid uptake of mercuric ion by goldfish. *Environ. Sci. Technol.* **5**: 1138-1139.

- McMurtry, M. J., D. L. Wales, W. A. Scheider, G. L. Beggs, and P. E. Dimond. 1989. Relationship of mercury concentrations in lake trout (*Salvelinus namaycush*) and smallmouth bass (*Micropterus dolomieu*) to the physical and chemical characteristics of Ontario lakes. *Can. J. Fish. Aquat. Sci.* **46**: 426-434.
- Meister, J. F., J. DiNunzio, and J. A. Cox. 1979. Source and mercury in a new impoundment. *Am. Water Works Assoc. J.* **71**: 574-576.
- Mierle, G., and R. Ingram. 1991. The role of humic substances in the mobilization of mercury from watersheds. *Water Air Soil Pollut.* **56**: 349-357.
- Miller, R. W. 1975. The role of humic acid in the uptake and release of mercury by freshwater sediments. *Verh. Int. Verein. Limnol.* **19**: 2082-2086.
- Miskimmin, B. M. 1989. The influence of dissolved organic carbon on methylmercury production and sediment-water partitioning in Precambrian Shield lakes. M.S. thesis. University of Manitoba, Winnipeg, Manitoba.

- Mortimer, D. C., and A. Kudo. 1975. Interaction between aquatic plants and bed sediments in mercury uptake from flowing water. *J. Environ. Qual.* **4**(4): 491-495.
- Nagase, H., Y. Ose, T. Sato, and T. Ishikawa. 1982. Methylation of mercury by humic substances in an aquatic environment. *Sci. Total Environ.* **24**: 133-142.
- Nagase, H., Y. Ose, T. Sato, and T. Ishikawa. 1984. Mercury methylation by compounds in humic material. *Sci. Total Environ.* **32**: 147-156.
- Newbury, R. W., and G. K. McCullough. 1984. Shoreline erosion and restabilization in the Southern Indian Lake reservoir. *Can. J. Fish. Aquat. Sci.* **41**: 558-566.
- Newbury, R. W., G. K. McCullough, and R. E. Hecky. 1984. The Southern Indian Lake and Churchill River Diversion. *Can. J. Fish. Aquat. Sci.* **41**: 548-557.
- Newfoundland and Labrador Hydro. 1981. Cat Arm hydroelectric development environmental impact statement addendum. Unpublished Report for Newfoundland and Labrador Hydro, Environmental Services Department.

- Nilsson, N. A. 1973. Biological effects of water-power exploitation in Sweden, and means of compensation for damage, p. 923-940. Comm. Int. des Grands Barrages, Madrid.
- Norstrom, R. J., A. E. McKinnon, and A. S. W. deFreitas. 1976. A bioenergetics-based model for pollutant accumulation by fish. Simulation of PCB and methylmercury residue levels in Ottawa River yellow perch (*Perca flavescens*). J. Fish. Res. Bd. Canada 33: 248-267.
- Nriagu, J. O. 1979. The Biogeochemistry of mercury in the Environment. Amsterdam; New York: Elsevier/North-Holland Biomedical Press (sole distributors for the USA and Canada, Elsevier/North-Holland, New York): 696 p.
- Nriagu, J. O., and J. M. Pacyna. 1988. Quantitative assessment of worldwide contamination of air, water and soils by trace metals. Nature 333: 134-139.
- Nuorteva, *et al.* 1979. Aquilo Ser. Zool. 19: 97.
- Olsson, M. 1976. Mercury level as a function of size and age in northern pike, one and five years after the mercury ban in Sweden. Ambio 5: 73-76.

- Olson, B. H., and R. C. Cooper. 1976. Comparison of aerobic and anaerobic methylation of mercuric chloride by San Francisco Bay sediments. *Water Res.* **10**: 113-116.
- Olson, K. R., and P. O. Fromm. 1973. Mercury uptake and ion distribution in the gills of rainbow trout (*Salmo gairdneri*): tissue scans with an electron microprobe. *J. Fish. Res. Bd. Canada* **30**: 1575-1578.
- Olson, K. R., H. L. Bergman, and P. O. Fromm. 1973. Uptake of methylmercuric chloride and mercuric chloride by trout: a study of uptake pathways into the whole animal and uptake by erythrocytes in vitro. *J. Fish. Res. Bd. Canada* **30**: 1293-1299.
- Paasivirta, J., J. Särkkä, K. Surma-Aho, T. Humpji, T. Kuokkanen, and M. Martinen. 1983. Food chain enrichment of organochlorine compounds and mercury in clean and polluted lakes of Finland. *Chemosphere* **12**: 239-252.
- Pan-Hou, H. S., and N. Imura. 1982. Involvement of mercury methylation in microbial mercury detoxification. *Arch. Microbiol.* **131**: 176-177.

- Parks, J. W., J. A. Sutton, and J. D. Hollinger. 1984. Mercury contamination of the Wabigoon/English/Winnipeg River system, 1980 -- Causes, effects and selected remedial measures. *In* R. J. Allan and T. Brydges [ed.] Mercury pollution in the Wabigoon-English River system of northwestern Ontario, and possible remedial measures. Available from J.W. Parks, OME, Thunder Bay.
- Patalas, K., and A. Salki. 1984. Effects of impoundment and diversion on the crustacean plankton of Southern Indian Lake. *Can. J. Fish. Aquat. Sci.* **41**: 613-637.
- Pearson, R. 1968a. Hard and soft acids and bases, HSAB, Part I, Fundamental principles. *J. Chem. Educ.* **45**: 581-587.
- Pearson, R. 1968b. Hard and soft acids and bases, HSAB, Part II, Underlying theories. *J. Chem. Educ.* **45**: 643-648.
- Pennachioni, A., R. Marchetti, and G. F. Gaggino. 1976. Inability of fish to methylate mercuric chloride *in vivo*. *J. Environ. Qual.* **5**: 451-454.
- Peters, R. H. 1986. The role of prediction in limnology. *Limnol. Oceanogr.* **31**: 1143-1159.

- Pfister, R. M. 1978. Biologically initiated auto-catalytic mercury conversion and its effect on elemental mobility. NTIS W78-02201. U.S. Dept. of Commerce, Springfield, VA.
- Phillips, G. R. 1976. Some quantitative aspects of mercury accumulation by rainbow trout. Ph.D. Thesis. Oreg. State Univ., Corvallis. 129 p.
- Phillips, G. R., and D. R. Buhler. 1978. The relative contributions of methylmercury from food or water to rainbow trout (*Salmo gairdneri*) in a controlled laboratory environment. Trans. Am. Fish. Soc. 107 (6): 853-861.
- Phillips, G. R., T. E. Lenhart, and R. W. Gregory. 1980. Relation between trophic position and mercury accumulation among fishes from the Tongue River Reservoir, Montana. Environ. Res. 22: 73-80.
- Platt, T., K. H. Mann, and R. E. Ulanowicz. 1981. Mathematical Models in Biological Oceanography. UNESCO Press, Paris, France.
- Ponce, R. A., and N. S. Bloom. 1991. Effect of pH on the bioaccumulation of low level, dissolved methylmercury by rainbow trout (*Oncorhynchus mykiss*). Water Air Soil Pollut. 56: 631-640.

- Popp, C. J., and F. Laquer. 1980. Trace metal transport and partitioning in the suspended sediments of the Rio Grande and tributaries in central New Mexico. *Chemosphere* 9: 89-98.
- Potter, L., D. Kidd, and D. Standiford. 1975. Bioamplification of mercury in man-made desert reservoir. *Environ. Sci. Technol.* 9 (1): 41-46.
- Putman, J. J. 1972. Quicksilver and slow death. *Nat. Geogr.* 142(4): 507-527.
- Pyrina, I. L. 1979. Primary production of the phytoplankton of the Volga, p. 180-194. *In* Ph.D. Mordukhai-Boltovskoi [ed.] *The river Volga and its life*. Junk, The Hague.
- Raeder, M. G., and E. Snekvik. 1941. Quecksilbergehalt mariner organismen. *Kongl. Vidensk. Selsk. Forhandl.* 13(42): 169-172.
- Rai, U. N., R. D. Tripathi, and N. Kumar. 1992. Bioaccumulation of chromium and toxicity on growth, photosynthetic pigments, photosynthesis, *in vivo* nitrate reductase activity and protein content in a chlorococcalean green alga *Glaucozystis nostochinearum* Itzigsohn. *Chemosphere* 25 (11): 1721-1732.

- Ramamoorthy, S., and K. Blumhagen. 1984. Uptake of Zn, Cd, and Hg by fish in the presence of competing compartments. *Can. J. Fish. Aquat. Sci.* **41**: 750-756.
- Ramlal, P. S., C. Anema, A. Furutani, R. E. Hecky, and J. W. M. Rudd. 1987. Mercury methylation and demethylation studies at Southern Indian Lake, Manitoba: 1981-1983. *Can. Tech. Rep. Fish. Aquat. Sci.* 1490: v + 35 p.
- Ramlal, P. S., J. W. M. Rudd, A. Furutani, and L. Xun. 1985. The effect of pH on methylmercury production and decomposition in lake sediments. *Can. J. Fish. Aquat. Sci.* **42**: 685-692.
- Ramlal, P. S., J. W. M. Rudd, and R. E. Hecky. 1986. Methods for measuring specific rates of mercury methylation and degradation and their use in determining factors controlling net rates of mercury methylation. *Appl. Environ. Microbiol.* **51** (1): 110-114.
- Ramsey, D. J. 1989. Measurements of methylation balance in Southern Indian Lake and Granville Lake, Manitoba, and in Sokatisewin Lake, Saskatchewan, 1988. Environment Canada, Ecological Report Series No. 89-2, Northern Flood Agreement, Manitoba: 95 p.

- Ramsey, D. J. 1990. Experimental studies of mercury dynamics in the Churchill River diversion, manitoba, CSEB, 1990 - Managing the effects of hydroelectric developments; Proceeding of a Symposium, April 6-7, 1989, Montréal, Québec. *In* C. E. Delise, and M. A. Bouchard [ed.] Collection Environnement et Géologie, université de Montréal **9**: 650 p.
- Ramsey, D. E., and P. S. Ramlal. 1987. Measurements of rates of production and degradation of methyl mercury and concentrations of total mercury in Southern Indian Lake, Cedar Lake, and Granville Lake, Manitoba: results of a survey conducted in July and August, 1985. *In* Technical Appendices to the Summary Report, Canada-Manitoba Agreement on the Study and Monitoring of Mercury in the Churchill River Diversion. Vol. 3. Chap. 13. Published by the Governments of Canada and Manitoba.
- Rankama, K., and Th. G. Sahama. 1950. *Geochemistry*. Univ. Chicago Press.
- Rask, M., and T.-R. Metsälä. 1991. Mercury concentrations in northern pike, *Esox lucius* L., in small lakes of Evo Area, southern Finland. *Water Air Soil Pollut.* **56**: 369-378.

- Ribeyre, F., A. Boudou, and R. Maury-Brachet. 1991. Multicompartment ecotoxicological models to study mercury bioaccumulation and transfer in freshwater systems. *Water Air Soil Pollut.* **56**: 641-652.
- Robinson, J. B., and O. H. Tuovinen. 1984. Mechanisms of microbial resistance and detoxification of mercury and organomercury compounds: physiological, biochemical, and genetic analyses. *Microbiol. Rev.* **48**: 95-124.
- Rodgers, D. W., and F. W. H. Beamish. 1981. Uptake of waterborne methylmercury by rainbow trout (*Salmo gairdneri*) in relation to oxygen consumption and methylmercury concentration. *Can. J. Fish. Aquat. Sci.* **38**: 1309-1315.
- Rodhe, W. 1964. Effects of impoundment on water chemistry and plankton in Lake Ransaren (Swedish Lapland). *Int. Ver. Limnol. Verh.* **15**: 437-443.
- Rogers, R. D. 1977. Abiotal methylation of mercury in soils. *J. Environ. Qual.* **6**: 463-467.
- Rogers, J. S., P. M. Huang, U. T. Hammer, and W. K. Liaw. 1984. Dynamics of desorption of mercury adsorbed on poorly crystalline oxides of manganese, iron, aluminum, and silicon. *Verh. Int. Verein. Limnol.* **22**: 283-288.

Romell, L. G. 1967. Die Reutbetriebe und ihr Geheimnis. *Studium Generale* 20(6): 362-369.

Royal Society of Canada. 1971. Special Symposium on Mercury in Man's Environment. Royal Society of Canada, Ottawa: 201 p.

Rucker, R. R., and D. F. Amend. 1969. Absorption and retention of organic mercurials by rainbow trout and chinook and sockeye salmon. *Progr. Fish-Cult.* 31: 197-201.

Rudd, J. W. M., and M. A. Turner. 1983a. The English-Wabigoon River system: II. Suppression of mercury and selenium bioaccumulation by suspended and bottom sediments. *Can. J. Fish. Aquat. Sci.* 40: 2218-2227.

Rudd, J. W. M., and M. A. Turner. 1983b. The English-Wabigoon River system: V. Mercury and selenium bioaccumulation as a function of aquatic primary productivity. *Can. J. Fish. Aquat. Sci.* 40: 2251-2259.

Rudd, J. W. M., A. Furutani, and M. A. Turner. 1980a. Mercury methylation by fish intestinal contents. *Appl. Environ. Microbiol.* 40 (4): 777-782.

- Rudd, J. W. M., M. A. Turner, B. E. Townsend, A. Swick, and A. Furutani. 1980b. Mechanism of movement of mercury into aquatic biota and a preliminary examination of some amelioration procedures. In T. A. Jackson [ed.] Mercury pollution in the Wabigoon-English River systems of Northwestern Ontario and possible remedial measures.
- Rudd, J. W. M., M. A. Turner, A. Furutani, A. L. Swick, and B. E. Townsend. 1983. The English-Wabigoon River system: I. A synthesis of recent research with a view towards mercury amelioration. *Can. J. Fish. Aquat. Sci.* **40**: 2206-2217.
- Ryder, R. A. 1965. A method for estimating the potential fish production of north-temperate lakes. *Trans. Am. Fish. Soc.* **94**: 214-218.
- S.A.S. 1985. SAS User's Guide. SAS Institute, Cary, N.C., U.S.A.
- Scheider, W. A., D. S. Jeffries, and P. J. Dillon. 1979. Effects of acidic precipitation on Precambrian freshwaters in southern Ontario. *J. Great Lakes Res.* **5**: 45-51.

- Schetagne, R. 1990. Suivi de la qualité de l'eau, du phytoplancton, du zooplancton et du benthos au complexe La Grande, territoire de la Baie James, CSEB, 1990 - Managing the effects of hydroelectric developments; Proceeding of a Symposium, April 6-7, 1989, Montréal, Québec. In C. E. Delise, and M. A. Bouchard [ed.] Collection Environnement et Géologie, université de Montréal 9: 650 p.
- Schneider, D. C., and R. L. Haedrich. 1989. Prediction limits of allometric equations: a reanalysis of Ryder's morphoedaphic index. *Can. J. Fish. Aquat. Sci.* 46: 503-508.
- Scott, D. P. 1974. Mercury concentration of white muscle in relation to age, growth, and condition in four species of fishes from Clay Lake, Ontario. *J. Fish. Res. Bd. Canada* 31: 1723-1729.
- Scott, D. P., and F. A. J. Armstrong. 1972. Mercury concentration in relation to size in several species of freshwater fishes from Manitoba and northwestern Ontario. *J. Fish. Res. Bd. Canada* 29: 1695-1690.
- Siegel, S. M., and B. Z. Siegel. 1975. Geothermal hazards: mercury emission. *Environ. Sci. Technol.* 9 (5): 473-474.

- Simpson, R. E., W. Horwitz, and C. A. Roy. 1974. Residues in food and feed -- surveys of mercury levels in fish and other foods. *Pesticides Monitoring Journal* 7: 127-138.
- Slemr, F., G. Schuster, and W. Seiler. 1985. Distribution, speciation, and budget of atmospheric mercury. *J. Atmos. Chem.* 3: 407-434.
- Sloan, R., and C. L. Schofield. 1983. Mercury levels in brook trout (*Salvelinus fontinalis*) from selected acid and lined Adirondack lakes. *Northeast. Environ. Sci.* 2: 165-170.
- Smith, F. A., R. P. Sharma, R. I. Lynn, and J. B. Low. 1974. Mercury and selected pesticide levels in fish and wildlife of Utah: I. Levels of mercury, DDT, DDE, Dieldrin and PCB in fish. *Bull. Environm. Contam. Toxicol.* 12 (2): 218-223.
- Soltero, R. A., and J. C. Wright. 1975. Primary production studies on a new reservoir; Bighorn Lake-Yellowtail Dam, Montana, U.S.A. *Freshw. Biol.* 5: 407-421.

- Sommers, L. E., and M. Floyd. 1974. Microbial transformations of mercury in aquatic environments. *Water Resources Res. Rept.* 54. Purdue Univ., Lafayette, Ind.
- Sorensen, E. M. 1991. *Metal Poisoning in Fish*. CRC Press, Inc., Boca Raton, FL.
- Spry, D. J., and J. G. Wiener. 1991. Metal bioavailability and toxicity to fish in low-alkalinity lakes: a critical review. *Environ. Pollut.* 71: 243-304.
- Stock, A., and F. Cucuel. 1934. Die Verbreitung des Quecksilbers. *Naturwiss.* 22/24: 390-393.
- Strange, N. E., R. A. Bodaly, and R. J. P. Fudge. 1991. Mercury concentrations of fish in Southern Indian Lake and Issett Lake, Manitoba, 1975-88: the effect of lake impoundment and Churchill River diversion. *Can. Tech. Rep. Fish. Aquat. Sci.* 1824: iv + 30 p.
- Strange, N. E. 1993. Mercury in fish in northern Manitoba reservoirs and associated waterbodies: results from 1992 sampling. Unpublished Report by N. E. Strange, North/South Consultants Inc., 202-1475 Chevrier Blvd. Winnipeg, Manitoba, R3T 1Y7.

- Strohal, P., and D. Huljev. 1971. Investigation of mercury pollutant interactions with humic acids by means of radiotracers. Proc. Symp. Nucl. Environ. Pollut., IAEA, Vienna: 439-446.
- Stroud, R. H. 1967. Summary. Reservoir fisheries resources symposium, Athens, GA., April 1967, p. 556-569. Published by So. Div., Am. Fish. Soc.
- Sumari, O., and K. Westman. 1969. The management of northern pike (*Esox lucius* L.) populations. Suom. Kalatalous 43: 1-24. (Finnish with English summary).
- Suns, K., C. Curry, and D. Russell. 1980. The effects of water quality and morphometric parameters on mercury uptake by yearling yellow perch. Technical Report LTS 80-1. Ontario Ministry of the Environment, Rexdale, Ontario.
- Surma-Aho, K., J. Paasivirta, S. Rekolainen, and M. Verta. 1986a. Organic and inorganic mercury in the food chain of some lakes and reservoirs in Finland. Chemosphere 15 (3): 353-372.

Surma-Aho, K., J. Paasivirta, S. Rekolainen, and M. Verta. 1986b. Organic and inorganic mercury in the food chain of some lakes and reservoirs in Finland. Publications of the Water Research Institute, National Board of Waters, Finland 65: 59-71.

Suzuki, T., T. Takemoto, H. Shimano, T. Miyama, H. Katsunuma, and Y. Kagawa. 1971. Mercury content in the blood in relation to dietary habit of the woman without any occupational exposure to mercury. Industrial Health Kawasaki 9: 1-8.

Suzuki, T., and M. Hatanaka. 1975. Experimental investigations on the biological concentration of mercury-II on the origin of mercury found in the body of young yellowtail. Bull. Jap. Soc. Sci. Fish 41(2): 228-231.

Takahashi, H., and K. Hirayama. 1971. Accelerated elimination of methylmercury from animals. Nature 232: 201-202.

Tessier, A., P. G. C. Campbell, and M. Bisson. 1980. Trace metal speciation in the Yamaska and St. François Rivers (Quebec). Can. J. Earth Sci. 17: 90-105.

- Tonomura, K., and F. Kanzaki. 1969. The reductive decomposition of organo-mercurials by cell-free extracts of a mercury-resistant pseudomonad. *Biochim. Biophys. Acta* **184**: 227-229.
- Tonomura, K., K. Furukawa, and M. Yamada. 1972. Microbial conversion of mercury compounds, p. 115-133. *In* F. Matsumara, G. M. Boush and T. Misato [ed.] *Environmental toxicology of pesticides*. Academic Press, New York.
- Turner, M. A., and J. W. M. Rudd. 1983. The English-Wabigoon River system: III. Selenium in lake enclosures: its geochemistry, bioaccumulation, and ability to reduce mercury bioaccumulation. *Can. J. Fish. Aquat. Sci.* **40**: 2228-2240.
- Turner, M. A., and A. L. Swick. 1983. The English-Wabigoon River system: IV. Interaction between mercury and selenium accumulated from waterborne and dietary sources by northern pike (*Esox lucius*). *Can. J. Fish. Aquat. Sci.* **40**: 2241-2250.
- Uthé, J. F., F. A. J. Armstrong, and M. P. Stainton. 1970. Mercury determination in fish samples by wet digestion and flameless atomic absorption spectrophotometry. *J. Fish. Res. Bd. Canada* **27**: 805.

- Uth , J. F., and E. G. Bligh. 1971. Preliminary survey of heavy metal contamination of Canadian freshwater fish. *J. Fish. Res. Bd. Canada* **28**: 786-788.
- Uth , J. F., F. M. Atton, and L. M. Roger. 1973. Uptake of mercury by caged rainbow trout (*Salmo gairdneri*) in the south Saskatchewan River. *J. Fish. Res. Bd. Canada* **30**: 643-650.
- Van Faassen, H. G. 1976. Methylation of mercury compounds in soil, sediment and sewage-sludge samples. *Plant Soil* **44**: 505-509.
- Varnasi, V., P. A. Robisch, and D. A. Malins. 1975. Structural alterations in fish epidermal mucus produced by waterborne lead and mercury. *Nature (Lond.)* **258**: 431-432.
- Verdon, R., D. Brouard, C. Demers, R. Lalumiere, M. Laperle, and R. Schetagne. 1991. Mercury evolution (1978-1988) in fishes of the La Grande Hydroelectric complex, Quebec, Canada. *Water Air Soil Pollut.* **56**: 405-417.
- Vermeer, K. 1972. The crayfish, *Orconectes virilis*, as an indicator of mercury contamination. *The Canadian Field-Naturalist* **86**: 123-125.

- Verta, M. 1984. The mercury cycle in lakes; some new hypotheses. *Aqua Fennica* **14** (2): 215-221.
- Verta, M. 1990. Changes in fish mercury concentrations in an intensively fished lake. *Can. J. Fish. Aquat. Sci.* **47**: 1888-1897.
- Verta, M., S. Rekolainen, and K. Kinnunen. 1986a. Causes of increased fish mercury levels in Finnish reservoirs. *Publications of the Water Research Institute, National Board of Waters, Finland* **65**: 44-58.
- Verta, M., S. Rekolainen, J. Mannio, and K. Surma-Aho. 1986b. The origin and level of mercury in Finnish forest lakes. *Publications of the Water Research Institute, National Board of Waters, Finland* **65**: 21-31.
- Vonk, J. W., and A. Kaars Sijpesteijn. 1973. Studies on the methylation of mercuric chloride by pure cultures of bacteria and fungi. *Antonie van Leeuwenhoek* **39**: 505-513.
- Westöo, G. 1966. Determination of methylmercury compounds in foodstuffs. I. Methylmercury compounds in fish, identification and determination. *Acta Chim. Scand.* **20**: 2131-2137.

- Westöo, G. 1973. Methyl mercury as percentage of total mercury in flesh and viscera of salmon and sea trout of various ages. *Science* **181**: 567-568.
- Wiener, J. G. 1983. Comparative analyses of fish populations in naturally acidic and circumneutral lakes in northern Wisconsin. FWS/OBS-80/40.16. U.S. Fish and Wildlife Service Report, Columbia, MO.
- Wiener, J. G., W. F. Fitzgerald, C. J. Watras, and R. G. Rada. 1990. Partitioning and bioavailability of mercury in an experimentally acidified Wisconsin lake. *Environ. Toxicol. Chem.* **9**: 909-918.
- Wiens, A. P., and D. M. Rosenberg. 1984. Effect of impoundment and river diversion on profundal macrobenthos of Southern Indian Lake, Manitoba. *Can. J. Fish. Aquat. Sci.* **41**: 638-648.
- Williams, L. G., and G. L. Coffee. 1975. Mercury monitoring technique using an organic substrate. *Journal WPCF* **47** (2): 354-361.
- Winfrey, M. R., and J. W. M. Rudd. 1990. Environmental factors affecting the formation of methylmercury in low pH lakes. *Environ. Toxicol. Chem.* **9**: 853-869.

Wisconsin Department of Natural Resources and Wisconsin Division of Health. 1988.

Health advisory for people who eat sport fish from Wisconsin waters. PUBL-IE-019. Madison, WI.

Wobeser, G., N. O. Nielsen, R. H. Dunlop, and F. M. Atton. 1970. Mercury concentrations in tissues of fish from the Saskatchewan River. *J. Fish. Res. Bd. Canada* 27 (4): 830-834.

Wood, J. M., S. Kennedy, and G. G. Rosen. 1968. Synthesis of methyl mercury compounds by extracts of a methanogenic bacterium. *Nature (London)* 220: 173-174.

Wood, J. M., M. W. Penley, and R. E. DeSimone. 1972. Mechanisms for methylation of mercury in the environment. *In* Mercury contamination in man and his environment. I.A.E.A. Tech. Rep. Ser. 137.

World Health Organization. 1976. Mercury: Environmental Health Criteria I. Geneva. 131 p.

- Wren, C. D., and H. R. MacCrimmon. 1983. Mercury levels in the sunfish, *Lepomis gibbosus*, relative to pH and other environmental variables of Precambrian Shield lakes. *Can. J. Fish. Aquat. Sci.* **40**: 1737-1744.
- Wren, C. D., and H. R. MacCrimmon. 1986. Comparative bioaccumulation of mercury in two adjacent freshwater ecosystems. *Wat. Res.* **20** (6): 763-769.
- Wright, D. R., and R. D. Hamilton. 1982. Release of methylmercury from sediments: effects of mercury concentration, low temperature, and nutrient addition. *Can. J. Fish. Aquat. Sci.* **39**: 1459-1466.
- Xun, L., N. E. R. Campbell, and J. W. M. Rudd. 1987. Measurements of specific rates of net methyl mercury production in the water column and surface sediments of acidified and circumneutral lakes. *Can. J. Fish. Aquat. Sci.* **44**: 750-757.
- Yamada, M., and K. Tonomura. 1972. Formation of methylmercury compounds from inorganic mercury by *Clostridium cochlearium*. *J. Ferment. Technol.* **50**: 159-166.

Yamaguchi, S., H. Matsumoto, S. Masuo, S. Kaku, and M. Hoshide. 1971.

Relationship between mercury content of hair and amount of fish consumed.

HSMHA Health Reports 86: 904-909.

APPENDIX A: RAW DATA FOR MERCURY IN FISH

Region: Manitoba

Species: Northern Pike

Reservoir: Southern Indian Lake

Year	Mean Mercury Concentration (ppm)
1978	0.7700
1979	0.5880
1980	0.6500
1981	0.7180
1982	0.7660
1983	0.7200
1984	0.7200
1985	0.6275
1986	0.7425
1987	0.6933
1988	0.7475
1992	0.3950

Reservoir: Threepoint

Year	Mean Mercury Concentration (ppm)
1980	1.28
1981	1.33

Reservoir: Footprint

Year	Mean Mercury Concentration (ppm)
1978	0.60
1980	1.38
1981	1.12

Reservoir: Wuskwatim

Year	Mean Mercury Concentration (ppm)
1979	0.91
1980	1.03
1981	0.80

Reservoir: Issett

Year	Mean Mercury Concentration (ppm)
1978	0.6080
1982	0.9004
1983	1.0371
1984	1.0867
1985	1.1248
1986	0.8956
1987	0.8091
1988	0.9724

Reservoir: Notigi

Year	Mean Mercury Concentration (ppm)
1980	1.95
1981	1.70
1982	1.85

Reservoir: Rat

Year	Mean Mercury Concentration (ppm)
1978	2.05

Control Lakes: Mean Mercury Concentration: 0.3983 ppm

Species: Walleye

Reservoir: Southern Indian Lake

Year	Mean Mercury Concentration (ppm)
1978	0.8000
1979	0.4880
1980	0.5625
1981	0.5760
1982	0.5975
1983	0.5100
1984	0.5200
1985	0.5867
1986	0.4400
1987	0.5233
1988	0.5475
1992	0.5050

Reservoir: Threepoint

Year	Mean Mercury Concentration (ppm)
1980	1.18
1981	1.35

Reservoir: Footprint

Year	Mean Mercury Concentration (ppm)
1978	0.82
1980	0.92
1981	1.10

Reservoir: Wuskwatim

Year	Mean Mercury Concentration (ppm)
1979	0.76
1980	1.00
1981	0.89

Reservoir: Issett

Year	Mean Mercury Concentration (ppm)
1978	1.5200
1982	0.7863
1983	1.3728
1984	0.4609
1985	1.0175
1986	1.3667
1987	0.6780
1988	0.9640

Reservoir: Notigi

Year	Mean Mercury Concentration (ppm)
1978	1.41
1980	2.90
1981	1.88
1982	1.23

Reservoir: Rat

Year	Mean Mercury Concentration (ppm)
1978	2.56
1979	2.32
1980	1.15

Control Lakes: Mean Mercury Concentration: 0.4024 ppm

Species: Lake Whitefish

Reservoir: Southern Indian Lake

Year	Mean Mercury Concentration (ppm)
1975	0.0600
1978	0.2200
1979	0.2100
1980	0.1800
1981	0.1580
1982	0.1400
1983	0.0950
1984	0.1400
1985	0.1050
1986	0.1175
1987	0.1167
1988	0.1100
1992	0.1350

Reservoir: Threepoint

Year	Mean Mercury Concentration (ppm)
1980	0.56
1981	0.23

Reservoir: Footprint

No Data

Reservoir: Wuskwatim

Year	Mean Mercury Concentration (ppm)
1981	0.33

Reservoir: Issett

Year	Mean Mercury Concentration (ppm)
1975	0.1458
1978	0.3240
1982	0.2076
1983	0.1700
1984	0.2293
1985	0.2488
1986	0.0893
1987	0.1830
1988	0.1706

Reservoir: Notigi

Year	Mean Mercury Concentration (ppm)
1980	0.12
1981	0.23

Reservoir: Rat

Year	Mean Mercury Concentration (ppm)
1978	0.40
1980	0.32

Control Lakes: Mean Mercury Concentration: 0.0480 ppm

Region: Quebec

Species: Northern Pike

Reservoir: Caniapiscau

Year	Mean Mercury Concentration (ppm)
1980	0.5990
1987	0.9127
1989	1.2917
1991	1.6903
1993	2.1159

Reservoir: La Grande 2

Year	Mean Mercury Concentration (ppm)
1978	0.5714
1982	1.2375
1984	2.4662
1986	2.3027
1988	2.8280
1990	2.8471
1992	2.4790

Reservoir: La Grande 3

Year	Mean Mercury Concentration (ppm)
1984	0.5054
1986	1.2870
1988	1.8325
1990	2.4127
1992	3.2581

Reservoir: La Grande 4

Year	Mean Mercury Concentration (ppm)
1987	0.7434
1989	0.9844
1991	1.0680
1993	1.3505

Reservoir: Opinaca

Year	Mean Mercury Concentration (ppm)
1978	0.3206
1984	1.9590
1986	1.5655
1988	1.8105
1990	2.4298
1992	2.5900

Control Lakes: Mean Mercury Concentration: 0.7968 ppm

Species: Walleye

Reservoir: La Grande 2

Year	Mean Mercury Concentration (ppm)
1978	0.6628
1982	2.0252
1984	2.7083
1986	2.4751
1988	3.1579
1990	2.9813
1992	2.7390

Reservoir: La Grande 3

Year	Mean Mercury Concentration (ppm)
1984	1.4863
1986	1.1033
1990	2.4127

Reservoir: Opinaca

Year	Mean Mercury Concentration (ppm)
1978	0.4304
1984	2.2837
1986	1.8928
1988	2.3505
1990	2.5832
1992	2.1273

Control Lakes: Mean Mercury Concentration: 0.7022 ppm

Species: Lake Whitefish

Reservoir: Caniapiscau

Year	Mean Mercury Concentration (ppm)
1980	0.1669
1987	0.4727
1989	0.5082
1991	0.5212
1993	0.3332

Reservoir: La Grande 2

Year	Mean Mercury Concentration (ppm)
1978	0.0988
1982	0.5133
1984	0.5659
1986	0.5061
1988	0.5015
1990	0.5009
1992	0.5067

Reservoir: La Grande 3

Year	Mean Mercury Concentration (ppm)
1984	0.3287
1986	0.3608
1988	0.4414
1990	0.3914
1992	0.3942

Reservoir: La Grande 4

Year	Mean Mercury Concentration (ppm)
1987	0.4400
1989	0.3998
1991	0.3825
1993	0.2957

Reservoir: Opinaca

Year	Mean Mercury Concentration (ppm)
1978	0.1056
1984	0.4730
1986	0.4403
1988	0.5757
1990	0.4890
1992	0.4763

Control Lakes: Mean Mercury Concentration: 0.1692 ppm

Region: Newfoundland

Species: Arctic Char

Reservoir: Cat Arm

Year	Mean Mercury Concentration (ppm)
1982	0.1550
1984	0.2518
1985	0.3209
1986	0.4926
1988	0.7825
1990	0.8515
1993	0.6258

Species: Brook Trout

Reservoir: Cat Arm

Year	Mean Mercury Concentration (ppm)
1982	0.1103
1984	0.1227
1985	0.1869
1986	0.2537
1988	0.3527
1990	0.4271
1993	0.2597

Species: Ouananiche

Reservoir: Long Pond

Year	Mean Mercury Concentration (ppm)
1989	0.81
1990	0.73
1991	0.64
1992	0.70

Species: Brook Trout

Reservoir: Long Pond

Year	Mean Mercury Concentration (ppm)
1989	0.23
1990	0.18
1991	0.18
1992	0.24

